



Documentazione Tubo a raggi X

Tube Documentation

Documentation du Tube

RTC 602 HS 0.6/1.0

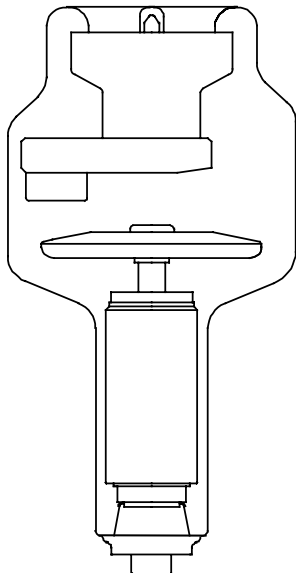

Versione speciale per sostituzione in cuffie GE-CGR e SIEMENS

Fornito con adattatore anodico

Special version for reloading in GE-CGR and SIEMENS housings

Supplied with anode end adaptation piece

Version spéciale pour remise en gaine GE-CGR et SIEMENS

Fourni avec adaptateur anodique

Nr. di matricola
Tube No.
Nr de série

CE 0051

Questa documentazione deve essere fornita all'utilizzatore del complesso tubo-guaina
The contents of this documentation must be transmitted to the user of the tube-assembly
Le contenu de cette documentation doit être transmis à l'utilisateur de la gaine équipée

| Documentazione N° Documentation N° N° de Documentation | Revisione Edition Version | Data di edizione Date of release Date de l'édition | Testo originale Original text Texte original |
|--|---------------------------------|--|--|
| 602Z6A | 0 | 28.07.2004 | italiano / italian / italien |

I.A.E Spa

via Fabio Filzi, 53 - 20032 CORMANO (MI) Italy
Tel: ++39-0266303255 Fax: ++39-026152544
<http://www.iae.it> e-mail: iaexray@iae.it





Sommario - Table of contents - Table des matières

| | |
|---|----|
| Sommario - Table of contents - Table des matières | 2 |
| Caratteristiche - Specifications - Spécifications | 3 |
| Dimensioni - Dimension - Dimensions | 4 |
| Curve di riscaldamento e raffreddamento dell'anodo Anode heating and cooling curves Courbes d'échauffement et de refroidissement de l'anode | 4 |
| CURVE DI CARICO SINGOLO - SINGLE LOAD RATING - ABAQUE DE CHARGE UNIQUE <input type="checkbox"/> 0.6 - 1 ~ - 3000 min ⁻¹ | 5 |
| CURVE DI CARICO SINGOLO - SINGLE LOAD RATING - ABAQUE DE CHARGE UNIQUE <input checked="" type="checkbox"/> 1.0 - 1 ~ - 3000 min ⁻¹ | 5 |
| CURVE DI CARICO SINGOLO - SINGLE LOAD RATING - ABAQUE DE CHARGE UNIQUE <input type="checkbox"/> 0.6 - 3 ~ - 3000 min ⁻¹ | 6 |
| CURVE DI CARICO SINGOLO - SINGLE LOAD RATING - ABAQUE DE CHARGE UNIQUE <input checked="" type="checkbox"/> 1.0 - 3 ~ - 3000 min ⁻¹ | 6 |
| CURVE DI CARICO SINGOLO - SINGLE LOAD RATING - ABAQUE DE CHARGE UNIQUE <input type="checkbox"/> 0.6 - 1 ~ - 10000 min ⁻¹ | 7 |
| CURVE DI CARICO SINGOLO - SINGLE LOAD RATING - ABAQUE DE CHARGE UNIQUE <input checked="" type="checkbox"/> 1.0 - 1 ~ - 10000 min ⁻¹ | 7 |
| CURVE DI CARICO SINGOLO - SINGLE LOAD RATING - ABAQUE DE CHARGE UNIQUE <input type="checkbox"/> 0.6 - 3 ~ - 10000 min ⁻¹ | 8 |
| CURVE DI CARICO SINGOLO - SINGLE LOAD RATING - ABAQUE DE CHARGE UNIQUE <input checked="" type="checkbox"/> 1.0 - 3 ~ - 10000 min ⁻¹ | 8 |
| Abaco per carichi in serie - Serial load rating - Abaque de charges successives <input type="checkbox"/> 0.6 - 1 ~ - 3000 min ⁻¹ | 9 |
| Abaco per carichi in serie - Serial load rating - Abaque de charges successives <input checked="" type="checkbox"/> 1.0 - 1 ~ - 3000 min ⁻¹ | 10 |
| Abaco per carichi in serie - Serial load rating - Abaque de charges successives <input type="checkbox"/> 0.6 - 3 ~ - 3000 min ⁻¹ | 11 |
| Abaco per carichi in serie - Serial load rating - Abaque de charges successives <input checked="" type="checkbox"/> 1.0 - 3 ~ - 3000 min ⁻¹ | 12 |
| Abaco per carichi in serie - Serial load rating - Abaque de charges successives <input type="checkbox"/> 0.6 - 1 ~ - 10000 min ⁻¹ | 13 |
| Abaco per carichi in serie - Serial load rating - Abaque de charges successives <input checked="" type="checkbox"/> 1.0 - 1 ~ - 10000 min ⁻¹ | 14 |
| Abaco per carichi in serie - Serial load rating - Abaque de charges successives <input type="checkbox"/> 0.6 - 3 ~ - 10000 min ⁻¹ | 15 |
| Abaco per carichi in serie - Serial load rating - Abaque de charges successives <input checked="" type="checkbox"/> 1.0 - 3 ~ - 10000 min ⁻¹ | 16 |
| Caratteristica di emissione del catodo Cathode emission characteristic Caractéristique d'émission de la cathode <input type="checkbox"/> 0.6 - 3 ~ - (± 0.2 A)17 | |
| Caratteristica di emissione del catodo Cathode emission characteristic Caractéristique d'émission de la cathode <input checked="" type="checkbox"/> 1.0 - 3 ~ - (± 0.2 A)17 | |

Dichiarazione di conformità

Questo prodotto soddisfa i requisiti essenziali della direttiva 93/42/CEE in accordo alle norme EN 60613 (IEC 613) e EN 60336 (IEC 336)

Declaration of conformity

This tube fulfils the essential requirements of the directive 93/42/EEC according to standard EN 60613 (IEC 613) and EN 60336 (IEC 336).

Confirmation de conformité

Ce tube remplit les exigences essentielles de la directive 93/42/CEE en accord avec les normes EN 60613 (IEC 613) et EN 60336 (IEC 336).



Caratteristiche - Specifications - Spécifications

| | | | |
|---|--------------------|--|---------------------|
| Macchie focali Focal spot Foyer | ☐ 0.6 ■ 1.0 | | (IEC 336, EN 60336) |
| Velocità di rotazione dell'anodo Anode speed Vitesse de l'anode | | 3000 min ⁻¹ 10000 min ⁻¹ | |
| Potenza anodica nominale Nominal anode input power Puissance anodique nominale | ☐ 17 kW ■ 28 kW | 30 kW 50 kW | (IEC 613, EN 60613) |
| Diametro anodico Anode diameter Diamètre de l'anode | | 102 mm | |
| Materiale anodico Anode material Matériau de l'anode | | RT-TZM-C | |
| Angolo anodico Anode angle Pente de l'anode | | 16 ° | |
| Campo di radiazione Radiation field Champ de rayonnement | | a 70 cm 38 cm a 100 cm 55 cm | |
| Filtrazione inerente Inherent filtration Filtration inhérente | | 0.7 mm Al eq | (IEC 522) |
| Capacità termica anodica Maximum anode heat content Chaleur maximale accumulée dans l'anode | | 450 kJ 600 kHU | |
| Dissipazione termica continua Continuous heat dissipation Dissipation thermique continue | | 1000 W 80 000 HU/min | |
| Dissipazione termica massima Maximum heat dissipation Dissipation thermique maximale | | 1500 W 125 000 HU/min | |
| Alta tensione nominale Nominal X-ray tube voltage Haute tension nominale | | 150 kV | |
| Massima corrente di filamento Max. filament current Courant dans le filament max. | | 5.4 A | |

I dati forniti nella presente documentazione si intendono riferiti a:

The data indicated in this documentation refer to:

Les données indiquées dans cette documentation sont calculées pour:

Potenza anodica di equilibrio termico
Equivalent anode input power
Puissance anodique d'équilibre thermique

300 W = % della capacità termica anodica
% of maximum anode heat content
% de chaleur max. accumulée dans l'anode

52%

Dimensioni - Dimension - Dimensions

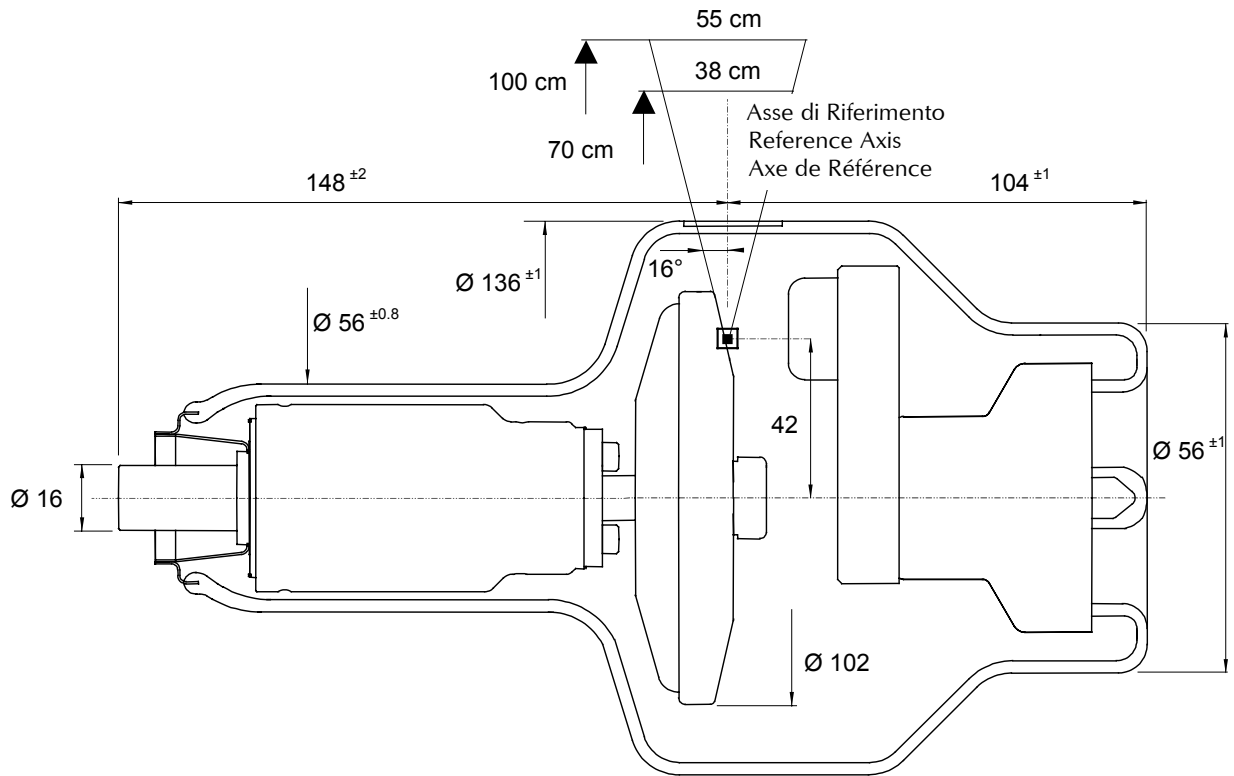

Curve di riscaldamento e raffreddamento dell'anodo
Anode heating and cooling curves
Courbes d'échauffement et de refroidissement de l'anode

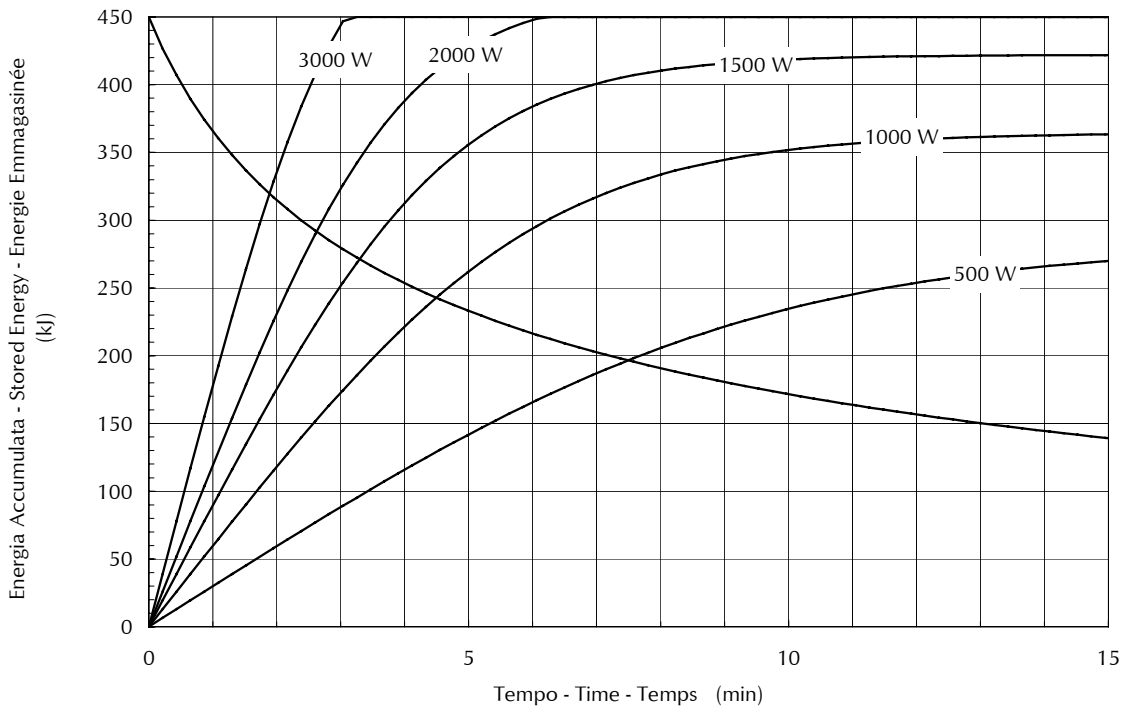



CURVE DI CARICO SINGOLO - SINGLE LOAD RATING - ABAQUE DE CHARGE UNIQUE

▣ **0.6 - 1 ~ - 3000 min⁻¹**

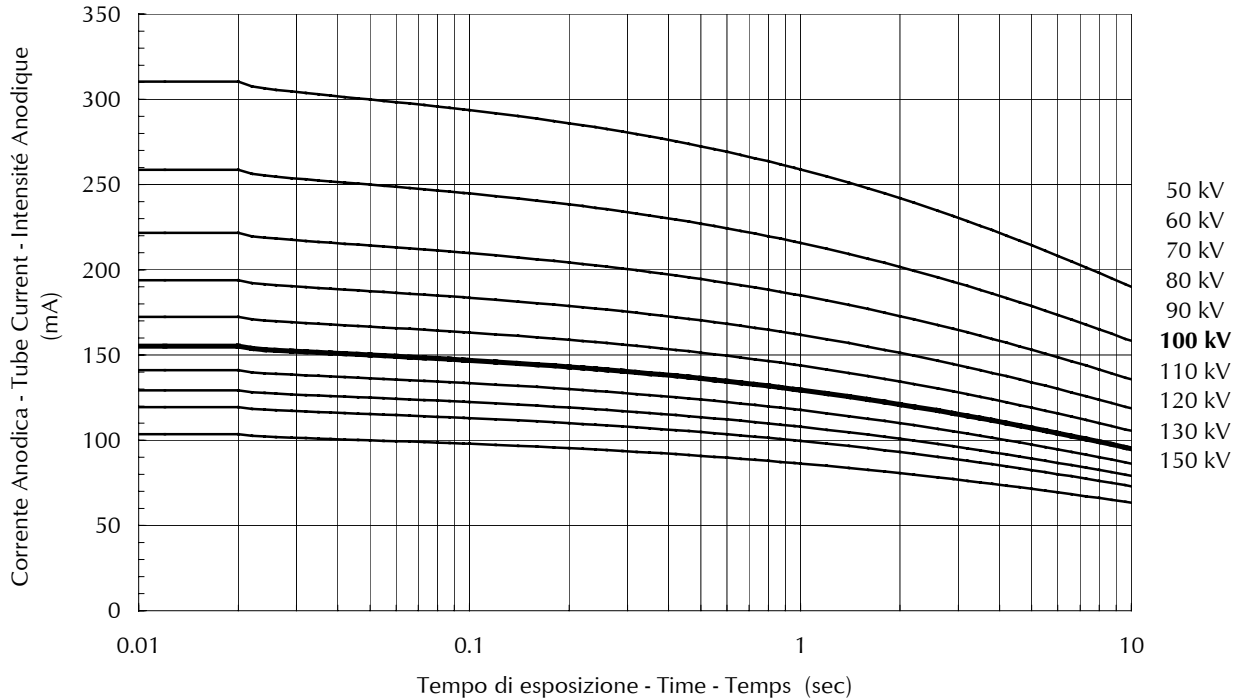

CURVE DI CARICO SINGOLO - SINGLE LOAD RATING - ABAQUE DE CHARGE UNIQUE

■ **1.0 - 1 ~ - 3000 min⁻¹**

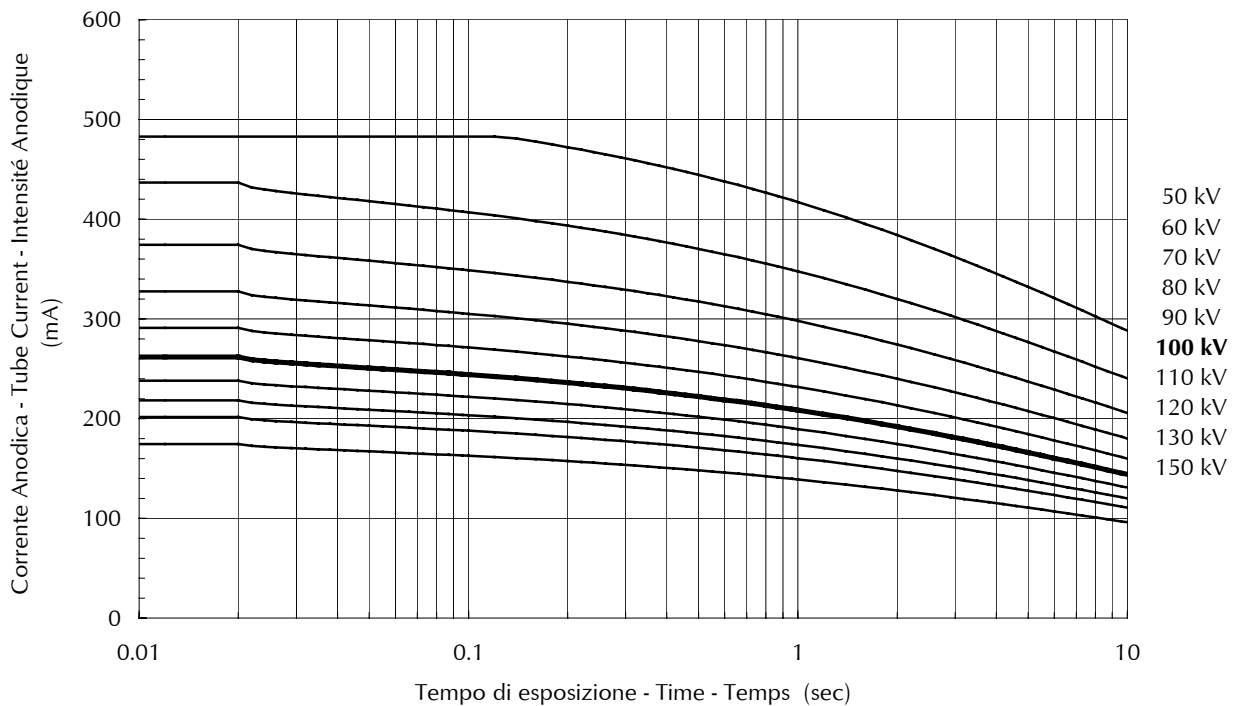



CURVE DI CARICO SINGOLO - SINGLE LOAD RATING - ABAQUE DE CHARGE UNIQUE

▣ 0.6 - 3 ~ - 3000 min⁻¹

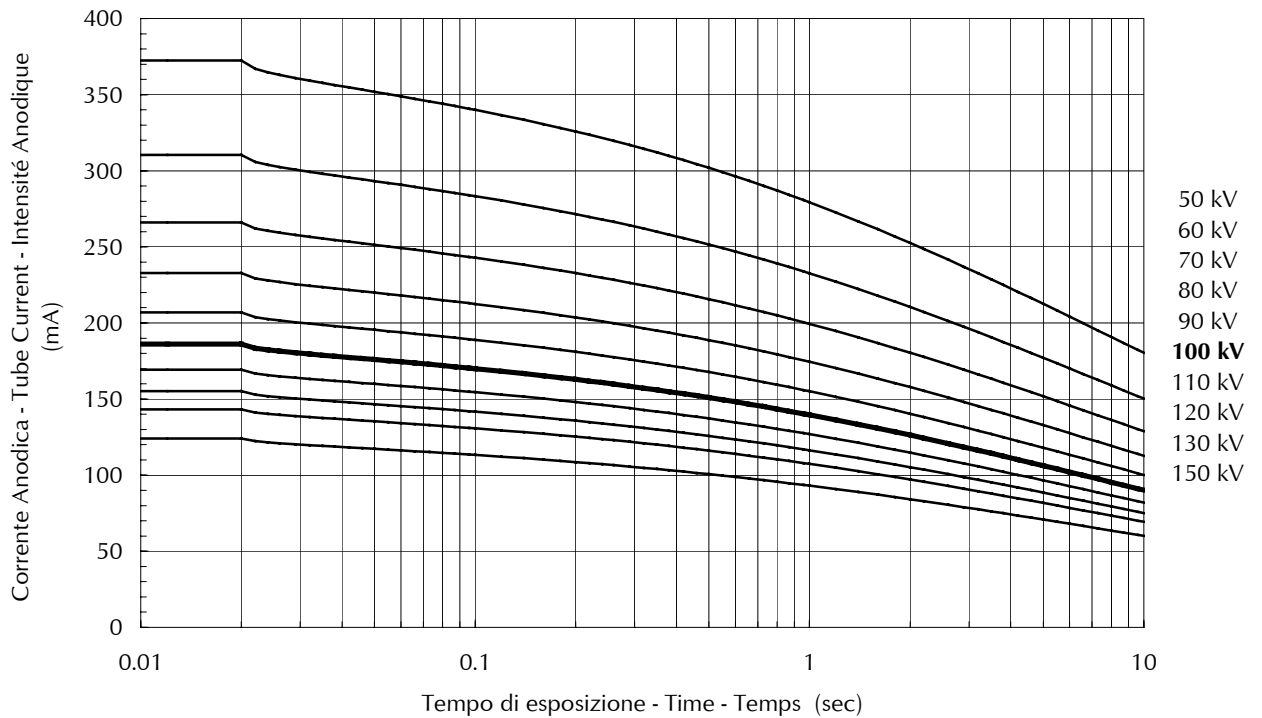

CURVE DI CARICO SINGOLO - SINGLE LOAD RATING - ABAQUE DE CHARGE UNIQUE

■ 1.0 - 3 ~ - 3000 min⁻¹

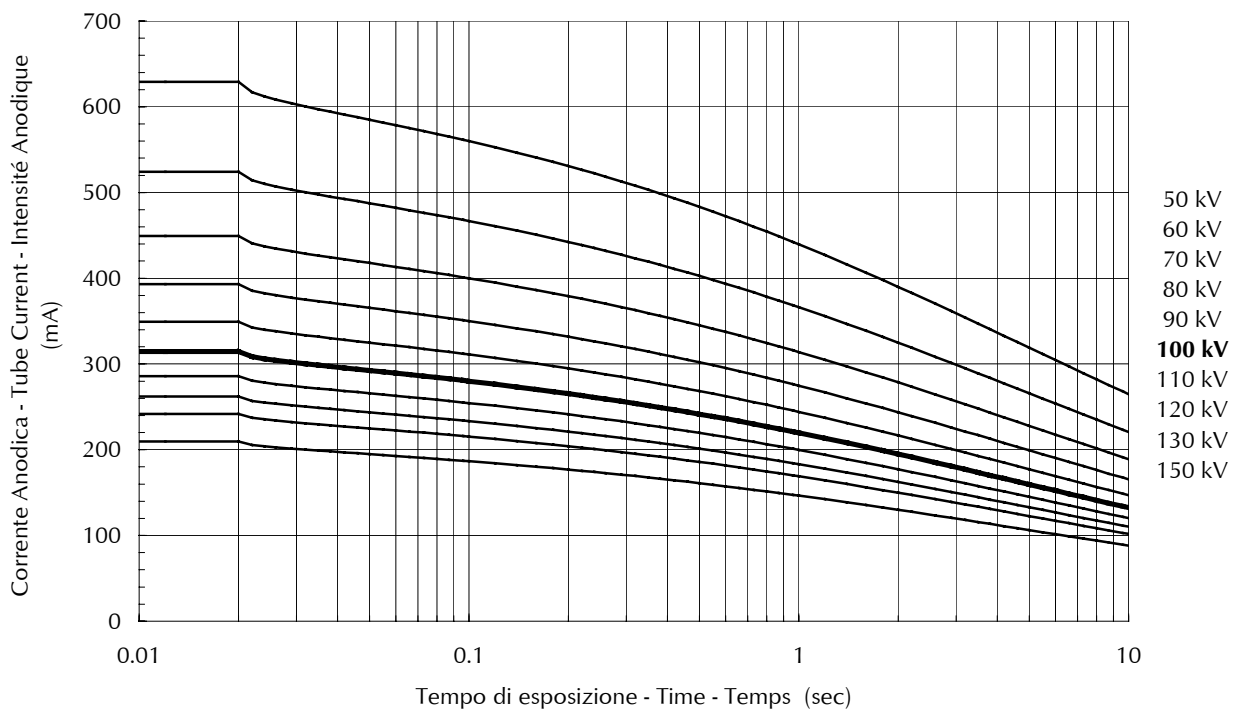



CURVE DI CARICO SINGOLO - SINGLE LOAD RATING - ABAQUE DE CHARGE UNIQUE

▣ 0.6 - 1 ~ - 10000 min⁻¹

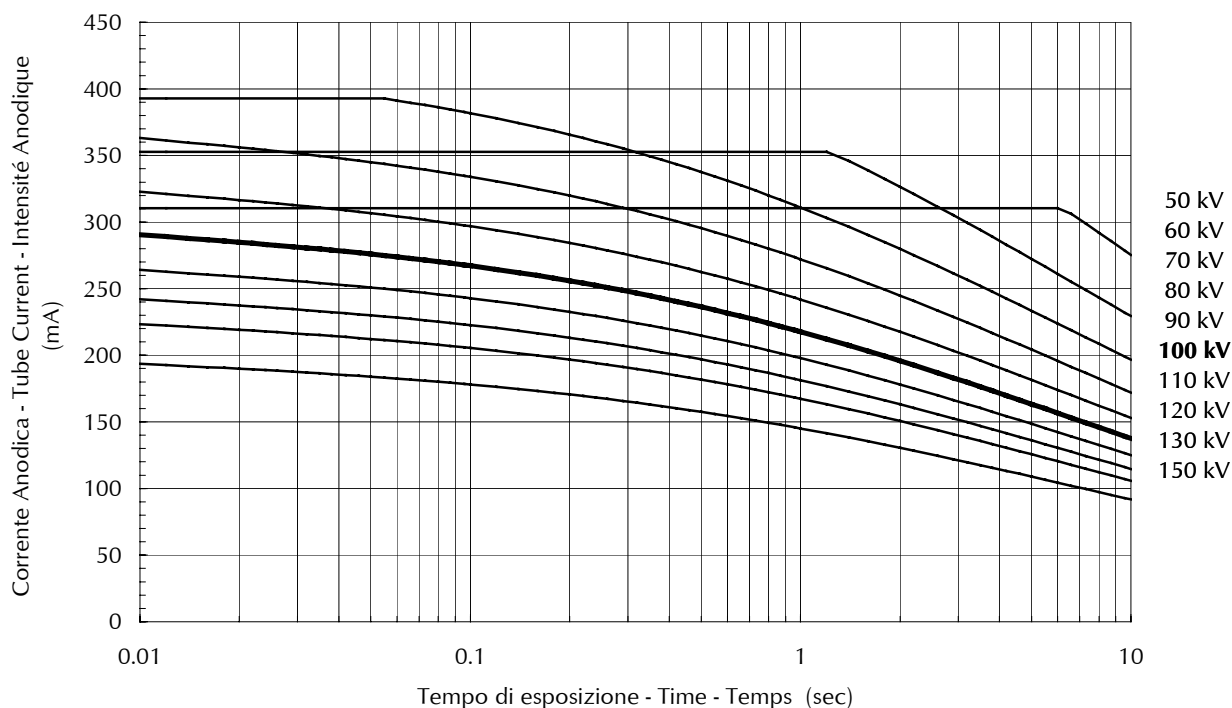

CURVE DI CARICO SINGOLO - SINGLE LOAD RATING - ABAQUE DE CHARGE UNIQUE

■ 1.0 - 1 ~ - 10000 min⁻¹

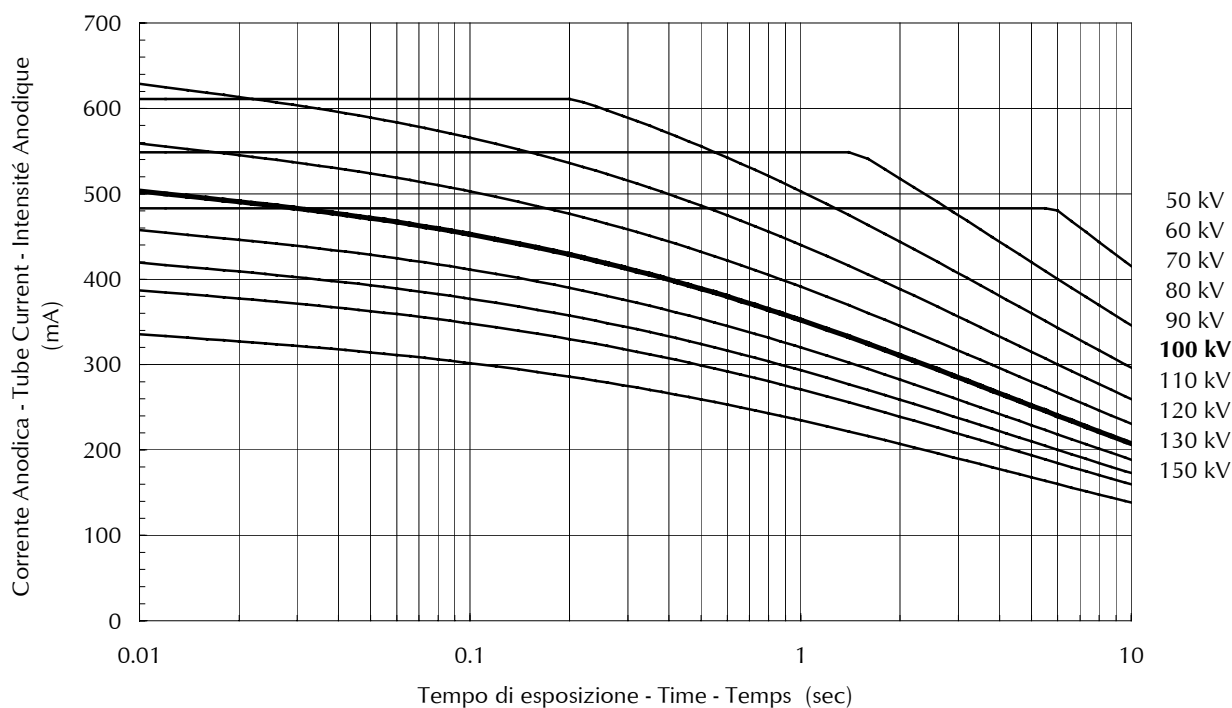



CURVE DI CARICO SINGOLO - SINGLE LOAD RATING - ABAQUE DE CHARGE UNIQUE

▣ **0.6 - 3 ~ - 10000 min⁻¹**

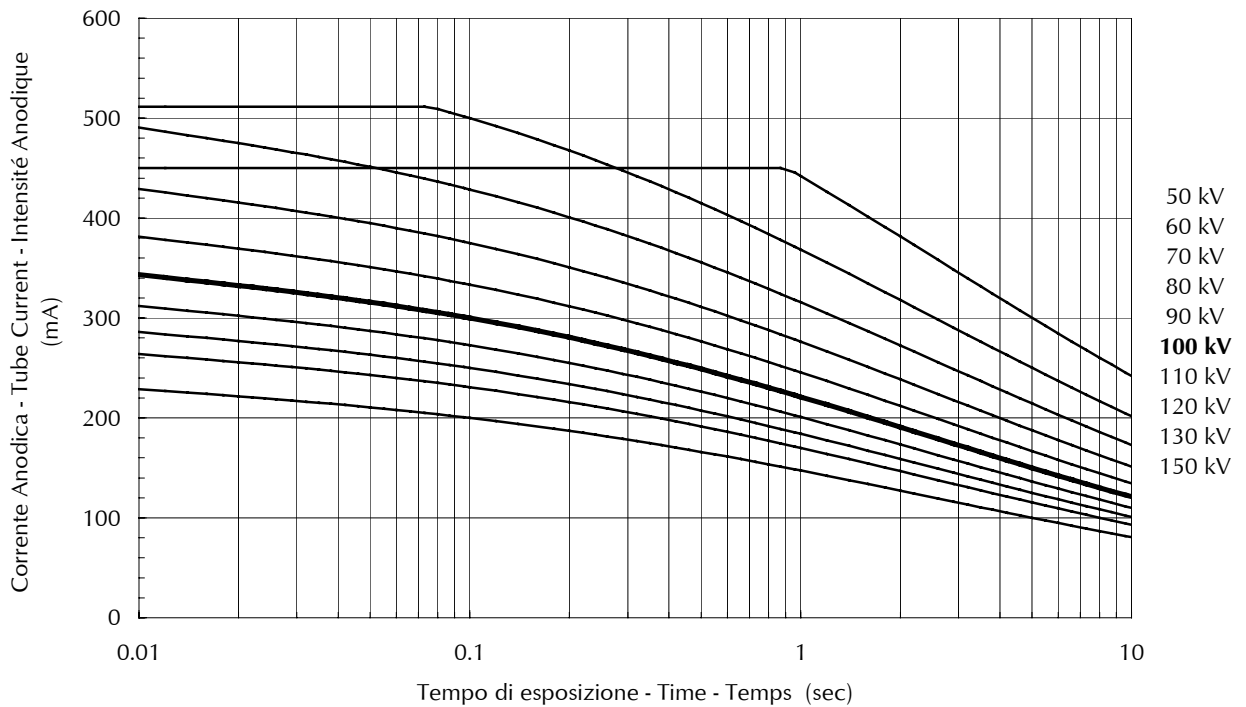

CURVE DI CARICO SINGOLO - SINGLE LOAD RATING - ABAQUE DE CHARGE UNIQUE

■ **1.0 - 3 ~ - 10000 min⁻¹**

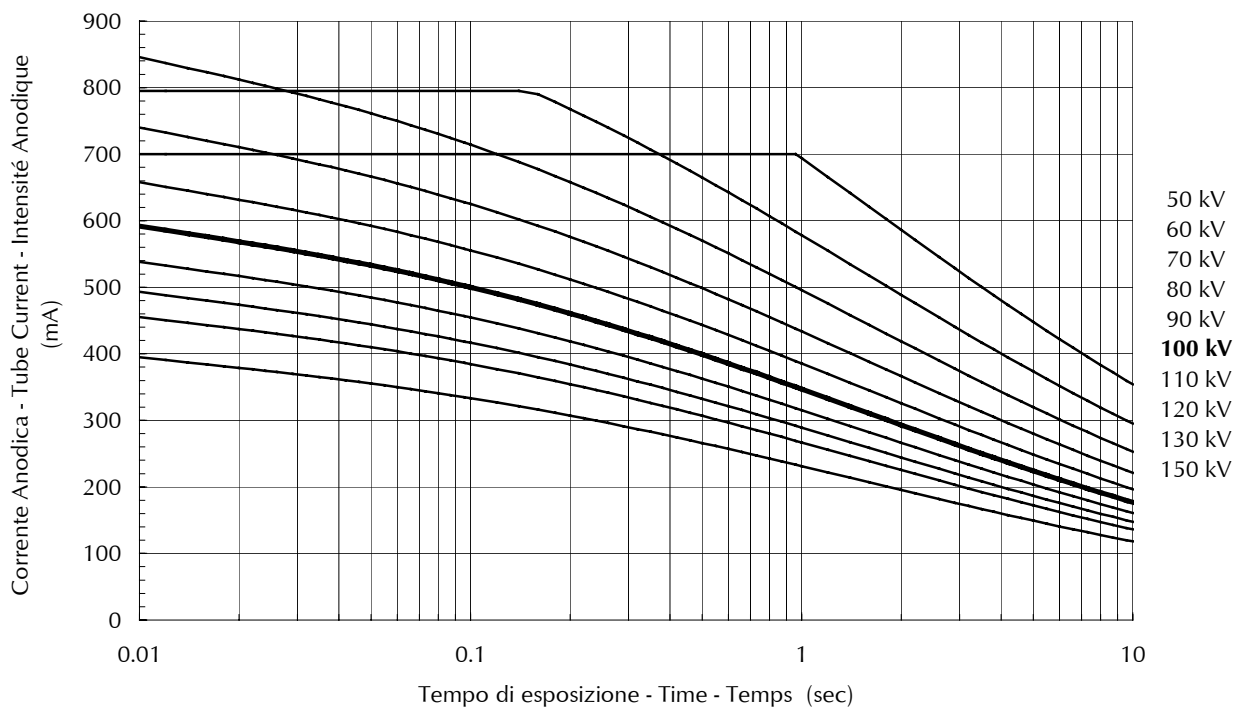



Abaco per carichi in serie - Serial load rating - Abaque de charges successives

▣ **0.6 - 1 ~ - 3000 min⁻¹**

| Potenza ammessa sul tubo in kW, per serie di n esposizioni, con frequenza z e durata di ogni esposizione in sec | | | | | | | | | | | | | | | n | |
|---|-------|-------|-------|-------|-------|-------|-------|-------|-------|-------|-------|-------|-------|-------|-------|-----|
| Anode input power as a function of n (N° of exposures in series), z (exp. rate per sec), the exposure time (sec) | | | | | | | | | | | | | | | | |
| Puissance anodique en fonction de n (N° d'exp. de la série), z (cadence d'exp. par sec), temps d'exposition (sec) | | | | | | | | | | | | | | | | |
| z | 0.010 | 0.020 | 0.030 | 0.040 | 0.050 | 0.060 | 0.080 | 0.100 | 0.120 | 0.140 | 0.160 | 0.180 | 0.200 | 0.220 | 0.250 | |
| 1 | 12.3 | 12.3 | 12.1 | 11.9 | 11.8 | 11.8 | 11.6 | 11.5 | 11.4 | 11.3 | 11.2 | 11.2 | 11.0 | 10.9 | 10.7 | 5 |
| 2 | 12.2 | 12.2 | 12.1 | 11.9 | 11.8 | 11.8 | 11.6 | 11.4 | 11.2 | 11.0 | 10.9 | 10.7 | 10.5 | 10.4 | 10.2 | |
| 3 | 12.2 | 12.2 | 12.0 | 11.9 | 11.8 | 11.7 | 11.4 | 11.2 | 11.0 | 10.8 | 10.6 | 10.4 | 10.2 | 10.0 | 9.8 | |
| 4 | 12.1 | 12.1 | 12.0 | 11.8 | 11.7 | 11.6 | 11.3 | 11.0 | 10.8 | 10.6 | 10.4 | 10.1 | 9.9 | 9.7 | 9.5 | |
| 5 | 12.1 | 12.1 | 11.9 | 11.8 | 11.6 | 11.5 | 11.2 | 10.9 | 10.6 | 10.4 | 10.2 | 9.9 | 9.7 | - | - | |
| 10 | 12.1 | 11.9 | 11.7 | 11.5 | 11.3 | 11.1 | 10.7 | 10.4 | - | - | - | - | - | - | - | |
| 15 | 12.1 | 11.9 | 11.6 | 11.3 | 11.1 | 10.9 | - | - | - | - | - | - | - | - | - | |
| 30 | 12.0 | 11.7 | 11.3 | - | - | - | - | - | - | - | - | - | - | - | - | |
| 1 | 12.2 | 12.2 | 12.1 | 11.9 | 11.8 | 11.8 | 11.6 | 11.4 | 11.2 | 11.0 | 10.9 | 10.7 | 10.5 | 10.4 | 10.2 | 10 |
| 2 | 12.1 | 12.1 | 12.0 | 11.8 | 11.7 | 11.5 | 11.3 | 11.0 | 10.8 | 10.6 | 10.3 | 10.1 | 9.9 | 9.7 | 9.5 | |
| 3 | 12.1 | 12.0 | 11.9 | 11.7 | 11.5 | 11.4 | 11.1 | 10.8 | 10.5 | 10.2 | 10.0 | 9.7 | 9.5 | 9.3 | 9.0 | |
| 4 | 12.1 | 12.0 | 11.8 | 11.6 | 11.4 | 11.2 | 10.9 | 10.5 | 10.2 | 9.9 | 9.7 | 9.4 | 9.2 | 8.9 | 8.6 | |
| 5 | 12.1 | 11.9 | 11.7 | 11.5 | 11.3 | 11.1 | 10.7 | 10.4 | 10.0 | 9.7 | 9.4 | 9.2 | 8.9 | - | - | |
| 10 | 12.1 | 11.8 | 11.5 | 11.2 | 10.9 | 10.6 | 10.2 | 9.7 | - | - | - | - | - | - | - | |
| 15 | 12.0 | 11.6 | 11.3 | 10.9 | 10.6 | 10.3 | - | - | - | - | - | - | - | - | - | |
| 30 | 11.9 | 11.3 | 10.9 | - | - | - | - | - | - | - | - | - | - | - | - | |
| 1 | 12.1 | 12.1 | 12.0 | 11.8 | 11.7 | 11.5 | 11.3 | 11.0 | 10.8 | 10.6 | 10.3 | 10.1 | 9.9 | 9.7 | 9.4 | 20 |
| 2 | 12.1 | 12.0 | 11.8 | 11.6 | 11.4 | 11.2 | 10.9 | 10.5 | 10.2 | 9.9 | 9.7 | 9.4 | 9.2 | 8.9 | 8.6 | |
| 3 | 12.1 | 11.9 | 11.7 | 11.4 | 11.2 | 11.0 | 10.6 | 10.2 | 9.8 | 9.5 | 9.2 | 8.9 | 8.7 | 8.4 | 8.0 | |
| 4 | 12.1 | 11.8 | 11.5 | 11.3 | 11.0 | 10.8 | 10.3 | 9.9 | 9.5 | 9.2 | 8.9 | 8.6 | 8.3 | 8.0 | 7.6 | |
| 5 | 12.1 | 11.8 | 11.5 | 11.2 | 10.9 | 10.6 | 10.1 | 9.7 | 9.3 | 8.9 | 8.6 | 8.3 | 8.0 | - | - | |
| 10 | 11.9 | 11.5 | 11.1 | 10.7 | 10.4 | 10.0 | 9.4 | 8.9 | - | - | - | - | - | - | - | |
| 15 | 11.8 | 11.3 | 10.8 | 10.4 | 10.0 | 9.6 | - | - | - | - | - | - | - | - | - | |
| 30 | 11.6 | 10.9 | 10.3 | - | - | - | - | - | - | - | - | - | - | - | - | |
| 1 | 12.1 | 12.0 | 11.8 | 11.6 | 11.4 | 11.2 | 10.9 | 10.5 | 10.2 | 9.9 | 9.7 | 9.4 | 9.2 | 8.9 | 8.6 | 40 |
| 2 | 12.1 | 11.8 | 11.5 | 11.3 | 11.0 | 10.8 | 10.3 | 9.9 | 9.5 | 9.2 | 8.9 | 8.5 | 8.3 | 8.0 | 7.6 | |
| 3 | 12.0 | 11.7 | 11.4 | 11.1 | 10.8 | 10.5 | 10.0 | 9.5 | 9.1 | 8.7 | 8.3 | 8.0 | 7.7 | 7.4 | 7.0 | |
| 4 | 12.0 | 11.6 | 11.2 | 10.9 | 10.5 | 10.2 | 9.7 | 9.2 | 8.7 | 8.3 | 7.9 | 7.6 | 7.3 | 7.0 | 6.6 | |
| 5 | 11.9 | 11.5 | 11.1 | 10.7 | 10.4 | 10.0 | 9.4 | 8.9 | 8.4 | 8.0 | 7.6 | 7.2 | 6.9 | - | - | |
| 10 | 11.8 | 11.2 | 10.6 | 10.1 | 9.7 | 9.3 | 8.6 | 8.0 | - | - | - | - | - | - | - | |
| 15 | 11.6 | 10.9 | 10.3 | 9.7 | 9.2 | 8.8 | - | - | - | - | - | - | - | - | - | |
| 30 | 11.3 | 10.4 | 9.6 | - | - | - | - | - | - | - | - | - | - | - | - | |
| 1 | 12.1 | 11.9 | 11.7 | 11.4 | 11.2 | 11.0 | 10.6 | 10.2 | 9.8 | 9.5 | 9.2 | 8.9 | 8.6 | 8.4 | 8.0 | 60 |
| 2 | 12.0 | 11.7 | 11.4 | 11.1 | 10.8 | 10.5 | 10.0 | 9.5 | 9.1 | 8.7 | 8.3 | 8.0 | 7.7 | 7.4 | 7.0 | |
| 3 | 12.0 | 11.5 | 11.2 | 10.8 | 10.4 | 10.1 | 9.5 | 9.0 | 8.5 | 8.1 | 7.7 | 7.4 | 7.1 | 6.8 | 6.4 | |
| 4 | 11.9 | 11.4 | 11.0 | 10.6 | 10.2 | 9.8 | 9.2 | 8.7 | 8.2 | 7.7 | 7.3 | 7.0 | 6.6 | 6.3 | 5.9 | |
| 5 | 11.8 | 11.3 | 10.8 | 10.4 | 10.0 | 9.6 | 8.9 | 8.4 | 7.8 | 7.4 | 7.0 | 6.6 | 6.3 | - | - | |
| 10 | 11.6 | 10.9 | 10.3 | 9.7 | 9.2 | 8.8 | 8.0 | 7.4 | - | - | - | - | - | - | - | |
| 15 | 11.5 | 10.6 | 9.9 | 9.3 | 8.7 | 8.3 | - | - | - | - | - | - | - | - | - | |
| 30 | 11.1 | 10.0 | 9.2 | - | - | - | - | - | - | - | - | - | - | - | - | |
| 1 | 12.1 | 11.8 | 11.5 | 11.3 | 11.0 | 10.8 | 10.3 | 9.9 | 9.5 | 9.2 | 8.9 | 8.5 | 8.3 | 8.0 | 7.6 | 80 |
| 2 | 12.0 | 11.6 | 11.2 | 10.9 | 10.5 | 10.2 | 9.7 | 9.2 | 8.7 | 8.3 | 7.9 | 7.6 | 7.3 | 7.0 | 6.6 | |
| 3 | 11.9 | 11.4 | 11.0 | 10.6 | 10.2 | 9.8 | 9.2 | 8.7 | 8.2 | 7.7 | 7.3 | 7.0 | 6.6 | 6.3 | 5.9 | |
| 4 | 11.8 | 11.3 | 10.8 | 10.3 | 9.9 | 9.5 | 8.9 | 8.3 | 7.7 | 7.3 | 6.9 | 6.5 | 6.2 | 5.9 | 5.5 | |
| 5 | 11.8 | 11.2 | 10.6 | 10.1 | 9.7 | 9.3 | 8.6 | 7.9 | 7.4 | 6.9 | 6.5 | 6.2 | 5.8 | - | - | |
| 10 | 11.5 | 10.7 | 10.0 | 9.4 | 8.9 | 8.4 | 7.6 | 6.9 | - | - | - | - | - | - | - | |
| 15 | 11.3 | 10.4 | 9.6 | 8.9 | 8.4 | 7.8 | - | - | - | - | - | - | - | - | - | |
| 30 | 10.9 | 9.7 | 8.8 | - | - | - | - | - | - | - | - | - | - | - | - | |
| 1 | 12.1 | 11.8 | 11.4 | 11.2 | 10.9 | 10.6 | 10.1 | 9.7 | 9.3 | 8.9 | 8.6 | 8.2 | 7.9 | 7.7 | 7.3 | 100 |
| 2 | 11.9 | 11.5 | 11.1 | 10.7 | 10.4 | 10.0 | 9.4 | 8.9 | 8.4 | 8.0 | 7.6 | 7.2 | 6.9 | 6.6 | 6.2 | |
| 3 | 11.8 | 11.3 | 10.8 | 10.4 | 10.0 | 9.6 | 8.9 | 8.4 | 7.8 | 7.4 | 7.0 | 6.6 | 6.3 | 6.0 | 5.6 | |
| 4 | 11.8 | 11.2 | 10.6 | 10.1 | 9.7 | 9.3 | 8.6 | 7.9 | 7.4 | 6.9 | 6.5 | 6.2 | 5.8 | 5.6 | 5.2 | |
| 5 | 11.7 | 11.0 | 10.4 | 9.9 | 9.4 | 9.0 | 8.3 | 7.6 | 7.1 | 6.6 | 6.2 | 5.8 | 5.5 | - | - | |
| 10 | 11.4 | 10.5 | 9.8 | 9.2 | 8.6 | 8.1 | 7.3 | 6.6 | - | - | - | - | - | - | - | |
| 15 | 11.2 | 10.2 | 9.4 | 8.7 | 8.0 | 7.5 | - | - | - | - | - | - | - | - | - | |
| 30 | 10.8 | 9.5 | 8.5 | - | - | - | - | - | - | - | - | - | - | - | - | |
| 1 | 12.0 | 11.6 | 11.3 | 10.9 | 10.6 | 10.3 | 9.7 | 9.2 | 8.8 | 8.4 | 8.0 | 7.7 | 7.4 | 7.1 | 6.7 | 150 |
| 2 | 11.8 | 11.3 | 10.8 | 10.4 | 10.0 | 9.6 | 8.9 | 8.4 | 7.8 | 7.4 | 7.0 | 6.6 | 6.3 | 6.0 | 5.6 | |
| 3 | 11.7 | 11.1 | 10.5 | 10.0 | 9.6 | 9.1 | 8.4 | 7.8 | 7.2 | 6.8 | 6.4 | 6.0 | 5.7 | 5.4 | 5.0 | |
| 4 | 11.6 | 10.9 | 10.3 | 9.7 | 9.2 | 8.8 | 8.0 | 7.4 | 6.8 | 6.3 | 5.9 | 5.5 | 5.2 | 4.9 | 4.6 | |
| 5 | 11.5 | 10.8 | 10.1 | 9.5 | 9.0 | 8.5 | 7.7 | 7.0 | 6.5 | 6.0 | 5.6 | 5.2 | 4.9 | - | - | |
| 10 | 11.2 | 10.2 | 9.4 | 8.7 | 8.0 | 7.5 | 6.6 | 5.9 | - | - | - | - | - | - | - | |
| 15 | 11.0 | 9.8 | 8.9 | 8.1 | 7.5 | 6.9 | - | - | - | - | - | - | - | - | - | |
| 30 | 10.4 | 9.0 | 7.9 | - | - | - | - | - | - | - | - | - | - | - | - | |
| 1 | 11.8 | 11.3 | 10.8 | 10.4 | 10.0 | 9.6 | 8.9 | 8.4 | 7.8 | 7.4 | 7.0 | 6.6 | 6.3 | 5.9 | 5.2 | 300 |
| 2 | 11.6 | 10.9 | 10.3 | 9.7 | 9.2 | 8.8 | 8.0 | 7.4 | 6.8 | 6.3 | 5.8 | 5.2 | 4.7 | 4.3 | 3.7 | |
| 3 | 11.4 | 10.6 | 9.9 | 9.3 | 8.7 | 8.2 | 7.4 | 6.7 | 6.2 | 5.7 | 5.1 | 4.5 | 4.1 | 3.7 | 3.3 | |
| 4 | 11.3 | 10.4 | 9.6 | 8.9 | 8.4 | 7.8 | 7.0 | 6.3 | 5.7 | 5.3 | 4.7 | 4.2 | 3.8 | 3.4 | 3.0 | |
| 5 | 11.2 | 10.2 | 9.4 | 8.6 | 8.0 | 7.5 | 6.6 | 5.9 | 5.4 | 4.9 | 4.5 | 4.0 | 3.6 | - | - | |
| 10 | 10.8 | 9.5 | 8.5 | 7.7 | 7.0 | 6.5 | 5.6 | 4.9 | - | - | - | - | - | - | - | |
| 15 | 10.4 | 9.0 | 7.9 | 7.1 | 6.4 | 5.8 | - | - | - | - | - | - | - | - | - | |
| 30 | 9.8 | 8.1 | 6.9 | - | - | - | - | - | - | - | - | - | - | - | - | |



Abaco per carichi in serie - Serial load rating - Abaque de charges successives

■ **1.0 - 1 ~ - 3000 min⁻¹**

| Potenza ammessa sul tubo in kW, per serie di n esposizioni, con frequenza z e durata di ogni esposizione in sec | | | | | | | | | | | | | | | n | |
|--|-------|-------|-------|-------|-------|-------|-------|-------|-------|-------|-------|-------|-------|-------|-------|-----|
| Anode input power as a function of n (N° of exposures in series), z (exp. rate per sec), the exposure time (sec) | | | | | | | | | | | | | | | | |
| Puissance anodique en fonction de n (N° d'exp. de la séries), z (cadence d'exp. par sec), temps d'exposition (sec) | | | | | | | | | | | | | | | | |
| z | 0.010 | 0.020 | 0.030 | 0.040 | 0.050 | 0.060 | 0.080 | 0.100 | 0.120 | 0.140 | 0.160 | 0.180 | 0.200 | 0.220 | 0.250 | |
| 1 | 20.6 | 20.6 | 20.2 | 19.9 | 19.7 | 19.5 | 19.3 | 19.0 | 18.8 | 18.6 | 18.5 | 18.3 | 18.0 | 17.8 | 17.4 | 5 |
| 2 | 20.5 | 20.5 | 20.2 | 19.9 | 19.7 | 19.5 | 19.2 | 18.8 | 18.4 | 18.1 | 17.7 | 17.4 | 17.1 | 16.8 | 16.3 | |
| 3 | 20.4 | 20.4 | 20.1 | 19.9 | 19.6 | 19.3 | 18.9 | 18.4 | 18.0 | 17.5 | 17.1 | 16.8 | 16.4 | 16.0 | 15.5 | |
| 4 | 20.3 | 20.3 | 20.0 | 19.7 | 19.4 | 19.1 | 18.6 | 18.1 | 17.6 | 17.1 | 16.7 | 16.3 | 15.9 | 15.5 | 15.0 | |
| 5 | 20.2 | 20.2 | 19.9 | 19.6 | 19.2 | 18.9 | 18.3 | 17.8 | 17.2 | 16.8 | 16.3 | 15.8 | 15.4 | - | - | |
| 10 | 20.2 | 20.0 | 19.5 | 19.0 | 18.6 | 18.2 | 17.5 | 16.8 | - | - | - | - | - | - | - | |
| 15 | 20.2 | 19.8 | 19.2 | 18.7 | 18.2 | 17.7 | - | - | - | - | - | - | - | - | - | |
| 30 | 20.1 | 19.4 | 18.6 | - | - | - | - | - | - | - | - | - | - | - | - | |
| 1 | 20.5 | 20.5 | 20.2 | 19.9 | 19.7 | 19.5 | 19.2 | 18.8 | 18.4 | 18.1 | 17.7 | 17.4 | 17.1 | 16.7 | 16.3 | 10 |
| 2 | 20.3 | 20.3 | 20.0 | 19.7 | 19.4 | 19.1 | 18.6 | 18.0 | 17.6 | 17.1 | 16.7 | 16.2 | 15.8 | 15.5 | 14.9 | |
| 3 | 20.2 | 20.2 | 19.8 | 19.4 | 19.1 | 18.7 | 18.1 | 17.5 | 16.9 | 16.4 | 15.9 | 15.5 | 15.0 | 14.6 | 14.0 | |
| 4 | 20.2 | 20.0 | 19.6 | 19.2 | 18.8 | 18.4 | 17.7 | 17.1 | 16.5 | 15.9 | 15.4 | 14.9 | 14.4 | 14.0 | 13.3 | |
| 5 | 20.2 | 19.9 | 19.5 | 19.0 | 18.6 | 18.2 | 17.4 | 16.7 | 16.0 | 15.4 | 14.9 | 14.4 | 13.9 | - | - | |
| 10 | 20.2 | 19.6 | 18.9 | 18.3 | 17.8 | 17.2 | 16.3 | 15.4 | - | - | - | - | - | - | - | |
| 15 | 20.1 | 19.3 | 18.5 | 17.8 | 17.2 | 16.6 | - | - | - | - | - | - | - | - | - | |
| 30 | 19.8 | 18.7 | 17.7 | - | - | - | - | - | - | - | - | - | - | - | - | |
| 1 | 20.3 | 20.3 | 20.0 | 19.7 | 19.4 | 19.1 | 18.6 | 18.0 | 17.6 | 17.1 | 16.6 | 16.2 | 15.8 | 15.5 | 14.9 | 20 |
| 2 | 20.2 | 20.0 | 19.6 | 19.2 | 18.8 | 18.4 | 17.7 | 17.1 | 16.4 | 15.9 | 15.3 | 14.8 | 14.4 | 13.9 | 13.3 | |
| 3 | 20.2 | 19.9 | 19.3 | 18.8 | 18.4 | 17.9 | 17.1 | 16.4 | 15.7 | 15.1 | 14.5 | 13.9 | 13.4 | 13.0 | 12.3 | |
| 4 | 20.2 | 19.7 | 19.1 | 18.6 | 18.0 | 17.6 | 16.7 | 15.8 | 15.1 | 14.4 | 13.8 | 13.2 | 12.7 | 12.2 | 11.6 | |
| 5 | 20.2 | 19.6 | 18.9 | 18.3 | 17.8 | 17.2 | 16.3 | 15.4 | 14.6 | 13.9 | 13.3 | 12.7 | 12.2 | - | - | |
| 10 | 19.9 | 19.0 | 18.2 | 17.4 | 16.7 | 16.0 | 14.9 | 13.9 | - | - | - | - | - | - | - | |
| 15 | 19.7 | 18.6 | 17.7 | 16.8 | 16.0 | 15.3 | - | - | - | - | - | - | - | - | - | |
| 30 | 19.3 | 17.8 | 16.6 | - | - | - | - | - | - | - | - | - | - | - | - | |
| 1 | 20.2 | 20.0 | 19.6 | 19.2 | 18.8 | 18.4 | 17.7 | 17.1 | 16.4 | 15.9 | 15.3 | 14.8 | 14.4 | 13.9 | 13.3 | 40 |
| 2 | 20.2 | 19.7 | 19.1 | 18.6 | 18.0 | 17.6 | 16.6 | 15.8 | 15.1 | 14.4 | 13.8 | 13.2 | 12.7 | 12.2 | 11.6 | |
| 3 | 20.2 | 19.4 | 18.7 | 18.1 | 17.5 | 16.9 | 15.9 | 15.0 | 14.2 | 13.5 | 12.8 | 12.2 | 11.7 | 11.2 | 10.5 | |
| 4 | 20.0 | 19.2 | 18.4 | 17.7 | 17.1 | 16.4 | 15.3 | 14.4 | 13.5 | 12.8 | 12.1 | 11.5 | 10.9 | 10.4 | 9.8 | |
| 5 | 19.9 | 19.0 | 18.2 | 17.4 | 16.7 | 16.0 | 14.9 | 13.9 | 13.0 | 12.2 | 11.5 | 10.9 | 10.4 | - | - | |
| 10 | 19.6 | 18.3 | 17.2 | 16.3 | 15.4 | 14.6 | 13.3 | 12.2 | - | - | - | - | - | - | - | |
| 15 | 19.3 | 17.8 | 16.6 | 15.5 | 14.5 | 13.7 | - | - | - | - | - | - | - | - | - | |
| 30 | 18.6 | 16.8 | 15.3 | - | - | - | - | - | - | - | - | - | - | - | - | |
| 1 | 20.2 | 19.8 | 19.3 | 18.8 | 18.4 | 17.9 | 17.1 | 16.4 | 15.7 | 15.0 | 14.5 | 13.9 | 13.4 | 13.0 | 12.3 | 60 |
| 2 | 20.2 | 19.4 | 18.7 | 18.1 | 17.5 | 16.9 | 15.9 | 15.0 | 14.2 | 13.5 | 12.8 | 12.2 | 11.7 | 11.2 | 10.5 | |
| 3 | 20.0 | 19.1 | 18.3 | 17.6 | 16.9 | 16.2 | 15.1 | 14.1 | 13.2 | 12.5 | 11.8 | 11.2 | 10.6 | 10.1 | 9.5 | |
| 4 | 19.9 | 18.8 | 17.9 | 17.1 | 16.4 | 15.7 | 14.5 | 13.4 | 12.5 | 11.7 | 11.0 | 10.4 | 9.9 | 9.4 | 8.7 | |
| 5 | 19.7 | 18.6 | 17.6 | 16.8 | 16.0 | 15.2 | 14.0 | 12.9 | 12.0 | 11.2 | 10.5 | 9.8 | 9.3 | - | - | |
| 10 | 19.3 | 17.8 | 16.6 | 15.5 | 14.5 | 13.7 | 12.3 | 11.1 | - | - | - | - | - | - | - | |
| 15 | 18.9 | 17.2 | 15.8 | 14.6 | 13.6 | 12.7 | - | - | - | - | - | - | - | - | - | |
| 30 | 18.2 | 16.0 | 14.4 | - | - | - | - | - | - | - | - | - | - | - | - | |
| 1 | 20.2 | 19.7 | 19.1 | 18.6 | 18.0 | 17.5 | 16.6 | 15.8 | 15.1 | 14.4 | 13.8 | 13.2 | 12.7 | 12.2 | 11.5 | 80 |
| 2 | 20.0 | 19.2 | 18.4 | 17.7 | 17.1 | 16.4 | 15.3 | 14.4 | 13.5 | 12.8 | 12.1 | 11.5 | 10.9 | 10.4 | 9.8 | |
| 3 | 19.8 | 18.8 | 17.9 | 17.1 | 16.4 | 15.7 | 14.5 | 13.4 | 12.5 | 11.7 | 11.0 | 10.4 | 9.9 | 9.4 | 8.7 | |
| 4 | 19.7 | 18.6 | 17.6 | 16.6 | 15.8 | 15.1 | 13.8 | 12.7 | 11.8 | 11.0 | 10.3 | 9.7 | 9.1 | 8.6 | 8.0 | |
| 5 | 19.5 | 18.3 | 17.2 | 16.3 | 15.4 | 14.6 | 13.3 | 12.2 | 11.2 | 10.4 | 9.7 | 9.1 | 8.6 | - | - | |
| 10 | 19.0 | 17.4 | 16.0 | 14.9 | 13.9 | 13.0 | 11.5 | 10.4 | - | - | - | - | - | - | - | |
| 15 | 18.6 | 16.8 | 15.2 | 14.0 | 12.9 | 12.0 | - | - | - | - | - | - | - | - | - | |
| 30 | 17.8 | 15.5 | 13.7 | - | - | - | - | - | - | - | - | - | - | - | - | |
| 1 | 20.2 | 19.5 | 18.9 | 18.3 | 17.7 | 17.2 | 16.2 | 15.4 | 14.6 | 13.9 | 13.3 | 12.7 | 12.2 | 11.1 | 9.8 | 100 |
| 2 | 19.9 | 19.0 | 18.2 | 17.4 | 16.7 | 16.0 | 14.9 | 13.9 | 13.0 | 12.2 | 11.5 | 10.9 | 10.3 | 9.5 | 8.4 | |
| 3 | 19.7 | 18.6 | 17.6 | 16.8 | 16.0 | 15.2 | 14.0 | 12.9 | 12.0 | 11.2 | 10.5 | 9.8 | 9.3 | 8.8 | 7.9 | |
| 4 | 19.5 | 18.3 | 17.2 | 16.3 | 15.4 | 14.6 | 13.3 | 12.2 | 11.2 | 10.4 | 9.7 | 9.1 | 8.6 | 8.1 | 7.5 | |
| 5 | 19.4 | 18.0 | 16.9 | 15.8 | 14.9 | 14.1 | 12.7 | 11.6 | 10.6 | 9.8 | 9.1 | 8.5 | 8.0 | - | - | |
| 10 | 18.8 | 17.1 | 15.6 | 14.4 | 13.3 | 12.4 | 10.9 | 9.8 | - | - | - | - | - | - | - | |
| 15 | 18.4 | 16.4 | 14.8 | 13.4 | 12.3 | 11.4 | - | - | - | - | - | - | - | - | - | |
| 30 | 17.5 | 15.0 | 13.2 | - | - | - | - | - | - | - | - | - | - | - | - | |
| 1 | 20.1 | 19.3 | 18.5 | 17.8 | 17.2 | 16.6 | 15.5 | 14.5 | 13.7 | 12.9 | 11.7 | 10.4 | 9.4 | 8.5 | 7.5 | 150 |
| 2 | 19.7 | 18.6 | 17.6 | 16.8 | 16.0 | 15.2 | 14.0 | 12.9 | 12.0 | 10.8 | 9.5 | 8.4 | 7.6 | 6.9 | 6.1 | |
| 3 | 19.5 | 18.2 | 17.0 | 16.0 | 15.1 | 14.3 | 13.0 | 11.8 | 10.9 | 10.0 | 8.7 | 7.8 | 7.0 | 6.3 | 5.6 | |
| 4 | 19.3 | 17.8 | 16.6 | 15.5 | 14.5 | 13.7 | 12.3 | 11.1 | 10.1 | 9.3 | 8.3 | 7.4 | 6.7 | 6.1 | 5.3 | |
| 5 | 19.1 | 17.5 | 16.2 | 15.0 | 14.0 | 13.1 | 11.7 | 10.5 | 9.6 | 8.8 | 8.1 | 7.2 | 6.5 | - | - | |
| 10 | 18.4 | 16.4 | 14.8 | 13.4 | 12.3 | 11.4 | 9.9 | 8.7 | - | - | - | - | - | - | - | |
| 15 | 17.9 | 15.6 | 13.8 | 12.4 | 11.3 | 10.3 | - | - | - | - | - | - | - | - | - | |
| 30 | 16.9 | 14.1 | 12.1 | - | - | - | - | - | - | - | - | - | - | - | - | |
| 1 | 19.7 | 18.6 | 17.6 | 16.8 | 16.0 | 15.2 | 14.0 | 12.9 | 10.8 | 9.2 | 8.1 | 7.2 | 6.5 | 5.9 | 5.2 | 300 |
| 2 | 19.3 | 17.8 | 16.6 | 15.5 | 14.5 | 13.7 | 11.7 | 9.4 | 7.8 | 6.7 | 5.8 | 5.2 | 4.7 | 4.3 | 3.7 | |
| 3 | 18.9 | 17.2 | 15.8 | 14.6 | 13.6 | 12.7 | 10.2 | 8.2 | 6.8 | 5.8 | 5.1 | 4.5 | 4.1 | 3.7 | 3.3 | |
| 4 | 18.6 | 16.8 | 15.2 | 14.0 | 12.9 | 12.0 | 9.5 | 7.6 | 6.3 | 5.4 | 4.7 | 4.2 | 3.8 | 3.4 | 3.0 | |
| 5 | 18.4 | 16.4 | 14.7 | 13.4 | 12.3 | 11.4 | 9.0 | 7.2 | 6.0 | 5.2 | 4.5 | 4.0 | 3.6 | - | - | |
| 10 | 17.5 | 15.0 | 13.1 | 11.7 | 10.5 | 9.6 | 8.1 | 6.5 | - | - | - | - | - | - | - | |
| 15 | 16.9 | 14.1 | 12.1 | 10.6 | 9.5 | 8.5 | - | - | - | - | - | - | - | - | - | |
| 30 | 15.6 | 12.4 | 10.3 | - | - | - | - | - | - | - | - | - | - | - | - | |



Abaco per carichi in serie - Serial load rating - Abaque de charges successives

0.6 - 3 ~ - 3000 min⁻¹

| Potenza ammessa sul tubo in kW, per serie di n esposizioni, con frequenza z e durata di ogni esposizione in sec | | | | | | | | | | | | | | | n | |
|---|-------|-------|-------|-------|-------|-------|-------|-------|-------|-------|-------|-------|-------|-------|-------|-----|
| Anode input power as a function of n (N° of exposures in series), z (exp. rate per sec), the exposure time (sec) | | | | | | | | | | | | | | | | |
| Puissance admissible en fonction de n (N° d'exp. de la série), z (cadence d'exp. par sec), temps d'exposition (sec) | | | | | | | | | | | | | | | | |
| z | 0.010 | 0.020 | 0.030 | 0.040 | 0.050 | 0.060 | 0.080 | 0.100 | 0.120 | 0.140 | 0.160 | 0.180 | 0.200 | 0.220 | 0.250 | |
| 1 | 14.7 | 14.7 | 14.4 | 14.2 | 14.1 | 14.0 | 13.8 | 13.6 | 13.5 | 13.3 | 13.2 | 13.1 | 12.9 | 12.8 | 12.5 | 5 |
| 2 | 14.6 | 14.6 | 14.4 | 14.2 | 14.1 | 14.0 | 13.7 | 13.5 | 13.2 | 13.0 | 12.7 | 12.5 | 12.3 | 12.1 | 11.8 | |
| 3 | 14.5 | 14.5 | 14.3 | 14.2 | 14.0 | 13.8 | 13.5 | 13.2 | 12.9 | 12.6 | 12.3 | 12.1 | 11.8 | 11.6 | 11.2 | |
| 4 | 14.5 | 14.5 | 14.3 | 14.1 | 13.9 | 13.7 | 13.3 | 13.0 | 12.6 | 12.3 | 12.0 | 11.7 | 11.5 | 11.2 | 10.8 | |
| 5 | 14.4 | 14.4 | 14.2 | 14.0 | 13.7 | 13.5 | 13.1 | 12.8 | 12.4 | 12.1 | 11.8 | 11.5 | 11.2 | - | - | |
| 10 | 14.4 | 14.2 | 13.9 | 13.6 | 13.3 | 13.1 | 12.6 | 12.1 | - | - | - | - | - | - | - | |
| 15 | 14.4 | 14.1 | 13.7 | 13.4 | 13.0 | 12.7 | - | - | - | - | - | - | - | - | - | |
| 30 | 14.3 | 13.8 | 13.3 | - | - | - | - | - | - | - | - | - | - | - | - | |
| 1 | 14.6 | 14.6 | 14.4 | 14.2 | 14.1 | 14.0 | 13.7 | 13.5 | 13.2 | 13.0 | 12.7 | 12.5 | 12.3 | 12.1 | 11.8 | 10 |
| 2 | 14.5 | 14.5 | 14.3 | 14.1 | 13.9 | 13.7 | 13.3 | 12.9 | 12.6 | 12.3 | 12.0 | 11.7 | 11.5 | 11.2 | 10.8 | |
| 3 | 14.4 | 14.4 | 14.1 | 13.9 | 13.6 | 13.4 | 13.0 | 12.6 | 12.2 | 11.8 | 11.5 | 11.2 | 10.9 | 10.6 | 10.2 | |
| 4 | 14.4 | 14.3 | 14.0 | 13.7 | 13.5 | 13.2 | 12.7 | 12.3 | 11.9 | 11.5 | 11.1 | 10.8 | 10.5 | 10.2 | 9.7 | |
| 5 | 14.4 | 14.2 | 13.9 | 13.6 | 13.3 | 13.0 | 12.5 | 12.0 | 11.6 | 11.2 | 10.8 | 10.4 | 10.1 | - | - | |
| 10 | 14.4 | 14.0 | 13.5 | 13.1 | 12.8 | 12.4 | 11.8 | 11.2 | - | - | - | - | - | - | - | |
| 15 | 14.3 | 13.8 | 13.3 | 12.8 | 12.4 | 12.0 | - | - | - | - | - | - | - | - | - | |
| 30 | 14.1 | 13.4 | 12.7 | - | - | - | - | - | - | - | - | - | - | - | - | |
| 1 | 14.5 | 14.5 | 14.3 | 14.0 | 13.9 | 13.7 | 13.3 | 12.9 | 12.6 | 12.3 | 12.0 | 11.7 | 11.4 | 11.2 | 10.8 | 20 |
| 2 | 14.4 | 14.3 | 14.0 | 13.7 | 13.5 | 13.2 | 12.7 | 12.3 | 11.9 | 11.5 | 11.1 | 10.8 | 10.4 | 10.1 | 9.7 | |
| 3 | 14.4 | 14.2 | 13.8 | 13.5 | 13.2 | 12.9 | 12.3 | 11.8 | 11.3 | 10.9 | 10.5 | 10.1 | 9.8 | 9.5 | 9.0 | |
| 4 | 14.4 | 14.1 | 13.7 | 13.3 | 12.9 | 12.6 | 12.0 | 11.5 | 10.9 | 10.5 | 10.1 | 9.7 | 9.3 | 9.0 | 8.5 | |
| 5 | 14.4 | 14.0 | 13.5 | 13.1 | 12.8 | 12.4 | 11.7 | 11.1 | 10.6 | 10.1 | 9.7 | 9.3 | 8.9 | - | - | |
| 10 | 14.2 | 13.6 | 13.0 | 12.5 | 12.0 | 11.6 | 10.8 | 10.1 | - | - | - | - | - | - | - | |
| 15 | 14.1 | 13.3 | 12.7 | 12.1 | 11.5 | 11.1 | - | - | - | - | - | - | - | - | - | |
| 30 | 13.8 | 12.8 | 12.0 | - | - | - | - | - | - | - | - | - | - | - | - | |
| 1 | 14.4 | 14.3 | 14.0 | 13.7 | 13.5 | 13.2 | 12.7 | 12.3 | 11.9 | 11.5 | 11.1 | 10.8 | 10.4 | 10.1 | 9.7 | 40 |
| 2 | 14.4 | 14.0 | 13.7 | 13.3 | 12.9 | 12.6 | 12.0 | 11.4 | 10.9 | 10.5 | 10.1 | 9.7 | 9.3 | 9.0 | 8.5 | |
| 3 | 14.4 | 13.9 | 13.4 | 13.0 | 12.6 | 12.2 | 11.5 | 10.9 | 10.3 | 9.8 | 9.4 | 9.0 | 8.6 | 8.2 | 7.7 | |
| 4 | 14.3 | 13.7 | 13.2 | 12.7 | 12.3 | 11.9 | 11.1 | 10.4 | 9.9 | 9.3 | 8.9 | 8.4 | 8.0 | 7.7 | 7.2 | |
| 5 | 14.2 | 13.6 | 13.0 | 12.5 | 12.0 | 11.6 | 10.8 | 10.1 | 9.5 | 8.9 | 8.5 | 8.0 | 7.6 | - | - | |
| 10 | 14.0 | 13.1 | 12.4 | 11.7 | 11.1 | 10.6 | 9.7 | 8.9 | - | - | - | - | - | - | - | |
| 15 | 13.8 | 12.8 | 11.9 | 11.2 | 10.6 | 10.0 | - | - | - | - | - | - | - | - | - | |
| 30 | 13.3 | 12.1 | 11.1 | - | - | - | - | - | - | - | - | - | - | - | - | |
| 1 | 14.4 | 14.2 | 13.8 | 13.5 | 13.2 | 12.9 | 12.3 | 11.8 | 11.3 | 10.9 | 10.5 | 10.1 | 9.8 | 9.5 | 9.0 | 60 |
| 2 | 14.4 | 13.9 | 13.4 | 13.0 | 12.6 | 12.2 | 11.5 | 10.9 | 10.3 | 9.8 | 9.4 | 8.9 | 8.6 | 8.2 | 7.7 | |
| 3 | 14.3 | 13.7 | 13.1 | 12.6 | 12.2 | 11.7 | 10.9 | 10.3 | 9.7 | 9.1 | 8.6 | 8.2 | 7.8 | 7.5 | 7.0 | |
| 4 | 14.2 | 13.5 | 12.9 | 12.3 | 11.8 | 11.3 | 10.5 | 9.8 | 9.2 | 8.6 | 8.1 | 7.7 | 7.3 | 6.9 | 6.5 | |
| 5 | 14.1 | 13.3 | 12.7 | 12.1 | 11.5 | 11.0 | 10.2 | 9.4 | 8.8 | 8.2 | 7.7 | 7.3 | 6.9 | - | - | |
| 10 | 13.8 | 12.8 | 11.9 | 11.2 | 10.5 | 10.0 | 9.0 | 8.2 | - | - | - | - | - | - | - | |
| 15 | 13.5 | 12.4 | 11.4 | 10.6 | 9.9 | 9.3 | - | - | - | - | - | - | - | - | - | |
| 30 | 13.0 | 11.6 | 10.4 | - | - | - | - | - | - | - | - | - | - | - | - | |
| 1 | 14.4 | 14.0 | 13.7 | 13.3 | 12.9 | 12.6 | 12.0 | 11.4 | 10.9 | 10.5 | 10.0 | 9.7 | 9.3 | 9.0 | 8.5 | 80 |
| 2 | 14.3 | 13.7 | 13.2 | 12.7 | 12.3 | 11.9 | 11.1 | 10.4 | 9.9 | 9.3 | 8.9 | 8.4 | 8.0 | 7.7 | 7.2 | |
| 3 | 14.2 | 13.5 | 12.9 | 12.3 | 11.8 | 11.3 | 10.5 | 9.8 | 9.2 | 8.6 | 8.1 | 7.7 | 7.3 | 6.9 | 6.5 | |
| 4 | 14.0 | 13.3 | 12.6 | 12.0 | 11.4 | 10.9 | 10.1 | 9.3 | 8.6 | 8.1 | 7.6 | 7.1 | 6.8 | 6.4 | 5.9 | |
| 5 | 14.0 | 13.1 | 12.4 | 11.7 | 11.1 | 10.6 | 9.7 | 8.9 | 8.2 | 7.7 | 7.2 | 6.7 | 6.3 | - | - | |
| 10 | 13.6 | 12.5 | 11.6 | 10.8 | 10.1 | 9.5 | 8.5 | 7.6 | - | - | - | - | - | - | - | |
| 15 | 13.3 | 12.1 | 11.0 | 10.2 | 9.4 | 8.8 | - | - | - | - | - | - | - | - | - | |
| 30 | 12.8 | 11.2 | 10.0 | - | - | - | - | - | - | - | - | - | - | - | - | |
| 1 | 14.4 | 14.0 | 13.5 | 13.1 | 12.7 | 12.4 | 11.7 | 11.1 | 10.6 | 10.1 | 9.7 | 9.3 | 8.9 | 8.6 | 8.1 | 100 |
| 2 | 14.2 | 13.6 | 13.0 | 12.5 | 12.0 | 11.6 | 10.8 | 10.1 | 9.5 | 8.9 | 8.5 | 8.0 | 7.6 | 7.3 | 6.8 | |
| 3 | 14.1 | 13.3 | 12.7 | 12.1 | 11.5 | 11.0 | 10.2 | 9.4 | 8.8 | 8.2 | 7.7 | 7.3 | 6.9 | 6.5 | 6.1 | |
| 4 | 14.0 | 13.1 | 12.4 | 11.7 | 11.1 | 10.6 | 9.7 | 8.9 | 8.2 | 7.7 | 7.2 | 6.7 | 6.3 | 6.0 | 5.5 | |
| 5 | 13.9 | 12.9 | 12.2 | 11.4 | 10.8 | 10.3 | 9.3 | 8.5 | 7.8 | 7.2 | 6.8 | 6.3 | 5.9 | - | - | |
| 10 | 13.5 | 12.3 | 11.3 | 10.4 | 9.7 | 9.1 | 8.0 | 7.2 | - | - | - | - | - | - | - | |
| 15 | 13.2 | 11.8 | 10.7 | 9.8 | 9.0 | 8.4 | - | - | - | - | - | - | - | - | - | |
| 30 | 12.6 | 10.9 | 9.6 | - | - | - | - | - | - | - | - | - | - | - | - | |
| 1 | 14.3 | 13.8 | 13.3 | 12.8 | 12.3 | 11.9 | 11.2 | 10.5 | 10.0 | 9.4 | 9.0 | 8.5 | 8.2 | 7.8 | 7.3 | 150 |
| 2 | 14.1 | 13.3 | 12.7 | 12.1 | 11.5 | 11.0 | 10.2 | 9.4 | 8.8 | 8.2 | 7.7 | 7.3 | 6.9 | 6.5 | 6.1 | |
| 3 | 13.9 | 13.0 | 12.3 | 11.6 | 11.0 | 10.4 | 9.5 | 8.7 | 8.0 | 7.4 | 6.9 | 6.5 | 6.1 | 5.8 | 5.3 | |
| 4 | 13.8 | 12.8 | 11.9 | 11.2 | 10.5 | 10.0 | 9.0 | 8.2 | 7.5 | 6.9 | 6.4 | 6.0 | 5.6 | 5.3 | 4.9 | |
| 5 | 13.6 | 12.6 | 11.7 | 10.9 | 10.2 | 9.6 | 8.6 | 7.7 | 7.1 | 6.5 | 6.0 | 5.6 | 5.2 | - | - | |
| 10 | 13.2 | 11.8 | 10.7 | 9.8 | 9.0 | 8.4 | 7.3 | 6.5 | - | - | - | - | - | - | - | |
| 15 | 12.8 | 11.3 | 10.1 | 9.1 | 8.3 | 7.6 | - | - | - | - | - | - | - | - | - | |
| 30 | 12.2 | 10.3 | 8.9 | - | - | - | - | - | - | - | - | - | - | - | - | |
| 1 | 14.1 | 13.3 | 12.7 | 12.1 | 11.5 | 11.0 | 10.2 | 9.4 | 8.8 | 8.2 | 7.7 | 7.2 | 6.5 | 5.9 | 5.2 | 300 |
| 2 | 13.8 | 12.8 | 11.9 | 11.2 | 10.5 | 10.0 | 9.0 | 8.2 | 7.5 | 6.7 | 5.8 | 5.2 | 4.7 | 4.3 | 3.7 | |
| 3 | 13.5 | 12.4 | 11.4 | 10.6 | 9.9 | 9.3 | 8.2 | 7.4 | 6.7 | 5.8 | 5.1 | 4.5 | 4.1 | 3.7 | 3.3 | |
| 4 | 13.3 | 12.1 | 11.0 | 10.2 | 9.4 | 8.8 | 7.7 | 6.9 | 6.2 | 5.4 | 4.7 | 4.2 | 3.8 | 3.4 | 3.0 | |
| 5 | 13.2 | 11.8 | 10.7 | 9.8 | 9.0 | 8.4 | 7.3 | 6.5 | 5.8 | 5.2 | 4.5 | 4.0 | 3.6 | - | - | |
| 10 | 12.6 | 10.9 | 9.6 | 8.6 | 7.7 | 7.1 | 6.0 | 5.2 | - | - | - | - | - | - | - | |
| 15 | 12.2 | 10.3 | 8.9 | 7.8 | 7.0 | 6.3 | - | - | - | - | - | - | - | - | - | |
| 30 | 11.3 | 9.1 | 7.6 | - | - | - | - | - | - | - | - | - | - | - | - | |



Abaco per carichi in serie - Serial load rating - Abaque de charges successives

■ **1.0 - 3 ~ - 3000 min⁻¹**

| Potenza ammessa sul tubo in kW, per serie di n esposizioni, con frequenza z e durata di ogni esposizione in sec | | | | | | | | | | | | | | | n | |
|--|-------|-------|-------|-------|-------|-------|-------|-------|-------|-------|-------|-------|-------|-------|-------|-----|
| Anode input power as a function of n (N° of exposures in series), z (exp. rate per sec), the exposure time (sec) | | | | | | | | | | | | | | | | |
| Puissance anodique en fonction de n (N° d'exp. de la séries), z (cadence d'exp. par sec), temps d'exposition (sec) | | | | | | | | | | | | | | | | |
| z | 0.010 | 0.020 | 0.030 | 0.040 | 0.050 | 0.060 | 0.080 | 0.100 | 0.120 | 0.140 | 0.160 | 0.180 | 0.200 | 0.220 | 0.250 | |
| 1 | 24.7 | 24.7 | 24.1 | 23.7 | 23.4 | 23.1 | 22.7 | 22.4 | 22.1 | 21.9 | 21.6 | 21.4 | 21.1 | 20.7 | 20.2 | 5 |
| 2 | 24.5 | 24.5 | 24.1 | 23.7 | 23.4 | 23.1 | 22.7 | 22.1 | 21.6 | 21.1 | 20.6 | 20.2 | 19.7 | 19.3 | 18.7 | |
| 3 | 24.3 | 24.3 | 24.0 | 23.6 | 23.2 | 22.9 | 22.2 | 21.5 | 20.9 | 20.4 | 19.8 | 19.3 | 18.8 | 18.4 | 17.7 | |
| 4 | 24.2 | 24.2 | 23.8 | 23.4 | 22.9 | 22.5 | 21.8 | 21.1 | 20.4 | 19.8 | 19.2 | 18.7 | 18.1 | 17.7 | 17.0 | |
| 5 | 24.1 | 24.1 | 23.6 | 23.2 | 22.7 | 22.3 | 21.5 | 20.7 | 20.0 | 19.3 | 18.7 | 18.1 | 17.6 | - | - | |
| 10 | 24.1 | 23.7 | 23.1 | 22.4 | 21.9 | 21.3 | 20.3 | 19.3 | - | - | - | - | - | - | - | |
| 15 | 24.1 | 23.4 | 22.7 | 21.9 | 21.3 | 20.6 | - | - | - | - | - | - | - | - | - | |
| 30 | 24.0 | 22.9 | 21.9 | - | - | - | - | - | - | - | - | - | - | - | - | |
| 1 | 24.5 | 24.5 | 24.1 | 23.7 | 23.4 | 23.1 | 22.7 | 22.1 | 21.6 | 21.1 | 20.6 | 20.2 | 19.7 | 19.3 | 18.7 | 10 |
| 2 | 24.2 | 24.2 | 23.8 | 23.3 | 22.9 | 22.5 | 21.8 | 21.1 | 20.4 | 19.8 | 19.2 | 18.6 | 18.1 | 17.6 | 16.9 | |
| 3 | 24.1 | 24.0 | 23.5 | 23.0 | 22.5 | 22.0 | 21.1 | 20.3 | 19.6 | 18.9 | 18.2 | 17.6 | 17.1 | 16.5 | 15.8 | |
| 4 | 24.1 | 23.8 | 23.2 | 22.7 | 22.1 | 21.6 | 20.6 | 19.7 | 18.9 | 18.2 | 17.5 | 16.8 | 16.2 | 15.7 | 14.9 | |
| 5 | 24.1 | 23.7 | 23.0 | 22.4 | 21.8 | 21.3 | 20.2 | 19.3 | 18.4 | 17.6 | 16.9 | 16.2 | 15.6 | - | - | |
| 10 | 24.1 | 23.2 | 22.3 | 21.5 | 20.7 | 20.0 | 18.7 | 17.6 | - | - | - | - | - | - | - | |
| 15 | 23.9 | 22.8 | 21.7 | 20.8 | 19.9 | 19.1 | - | - | - | - | - | - | - | - | - | |
| 30 | 23.4 | 21.9 | 20.6 | - | - | - | - | - | - | - | - | - | - | - | - | |
| 1 | 24.2 | 24.2 | 23.8 | 23.3 | 22.9 | 22.5 | 21.8 | 21.1 | 20.4 | 19.8 | 19.2 | 18.6 | 18.1 | 17.6 | 16.9 | 20 |
| 2 | 24.1 | 23.8 | 23.2 | 22.7 | 22.1 | 21.6 | 20.6 | 19.7 | 18.9 | 18.2 | 17.5 | 16.8 | 16.2 | 15.7 | 14.9 | |
| 3 | 24.1 | 23.6 | 22.8 | 22.2 | 21.5 | 20.9 | 19.8 | 18.8 | 17.9 | 17.1 | 16.4 | 15.7 | 15.0 | 14.5 | 13.7 | |
| 4 | 24.1 | 23.3 | 22.5 | 21.8 | 21.1 | 20.4 | 19.2 | 18.1 | 17.2 | 16.3 | 15.5 | 14.8 | 14.2 | 13.6 | 12.8 | |
| 5 | 24.1 | 23.1 | 22.3 | 21.4 | 20.7 | 20.0 | 18.7 | 17.5 | 16.5 | 15.6 | 14.8 | 14.1 | 13.5 | - | - | |
| 10 | 23.7 | 22.4 | 21.3 | 20.2 | 19.3 | 18.4 | 16.9 | 15.6 | - | - | - | - | - | - | - | |
| 15 | 23.4 | 21.9 | 20.5 | 19.4 | 18.3 | 17.4 | - | - | - | - | - | - | - | - | - | |
| 30 | 22.8 | 20.8 | 19.1 | - | - | - | - | - | - | - | - | - | - | - | - | |
| 1 | 24.1 | 23.8 | 23.2 | 22.7 | 22.1 | 21.6 | 20.6 | 19.7 | 18.9 | 18.2 | 17.5 | 16.8 | 16.2 | 15.7 | 14.9 | 40 |
| 2 | 24.1 | 23.3 | 22.5 | 21.8 | 21.1 | 20.4 | 19.2 | 18.1 | 17.1 | 16.3 | 15.5 | 14.8 | 14.1 | 13.6 | 12.8 | |
| 3 | 24.0 | 23.0 | 22.0 | 21.1 | 20.3 | 19.6 | 18.2 | 17.0 | 16.0 | 15.1 | 14.3 | 13.5 | 12.9 | 12.3 | 11.5 | |
| 4 | 23.8 | 22.7 | 21.6 | 20.6 | 19.7 | 18.9 | 17.5 | 16.2 | 15.2 | 14.2 | 13.4 | 12.6 | 12.0 | 11.4 | 10.6 | |
| 5 | 23.7 | 22.4 | 21.2 | 20.2 | 19.2 | 18.4 | 16.9 | 15.6 | 14.5 | 13.5 | 12.7 | 11.9 | 11.3 | - | - | |
| 10 | 23.1 | 21.4 | 20.0 | 18.7 | 17.5 | 16.5 | 14.8 | 13.5 | - | - | - | - | - | - | - | |
| 15 | 22.7 | 20.7 | 19.1 | 17.7 | 16.4 | 15.4 | - | - | - | - | - | - | - | - | - | |
| 30 | 21.9 | 19.4 | 17.4 | - | - | - | - | - | - | - | - | - | - | - | - | |
| 1 | 24.1 | 23.6 | 22.8 | 22.2 | 21.5 | 20.9 | 19.8 | 18.8 | 17.9 | 17.1 | 16.3 | 15.7 | 15.0 | 14.4 | 13.7 | 60 |
| 2 | 24.0 | 23.0 | 22.0 | 21.1 | 20.3 | 19.6 | 18.2 | 17.0 | 16.0 | 15.1 | 14.3 | 13.5 | 12.9 | 12.3 | 11.5 | |
| 3 | 23.8 | 22.5 | 21.4 | 20.4 | 19.5 | 18.6 | 17.1 | 15.9 | 14.8 | 13.8 | 13.0 | 12.3 | 11.6 | 11.0 | 10.2 | |
| 4 | 23.6 | 22.2 | 20.9 | 19.8 | 18.8 | 17.9 | 16.3 | 15.0 | 13.9 | 12.9 | 12.1 | 11.4 | 10.7 | 10.1 | 9.4 | |
| 5 | 23.4 | 21.9 | 20.5 | 19.3 | 18.3 | 17.3 | 15.7 | 14.3 | 13.2 | 12.2 | 11.4 | 10.7 | 10.0 | - | - | |
| 10 | 22.7 | 20.7 | 19.1 | 17.6 | 16.4 | 15.4 | 13.6 | 12.2 | - | - | - | - | - | - | - | |
| 15 | 22.3 | 20.0 | 18.1 | 16.5 | 15.2 | 14.1 | - | - | - | - | - | - | - | - | - | |
| 30 | 21.3 | 18.4 | 16.2 | - | - | - | - | - | - | - | - | - | - | - | - | |
| 1 | 24.1 | 23.3 | 22.5 | 21.8 | 21.1 | 20.4 | 19.2 | 18.1 | 17.1 | 16.3 | 15.5 | 14.8 | 14.1 | 13.1 | 11.5 | 80 |
| 2 | 23.8 | 22.7 | 21.6 | 20.6 | 19.7 | 18.9 | 17.5 | 16.2 | 15.2 | 14.2 | 13.4 | 12.6 | 12.0 | 11.4 | 10.1 | |
| 3 | 23.6 | 22.2 | 20.9 | 19.8 | 18.8 | 17.9 | 16.3 | 15.0 | 13.9 | 12.9 | 12.1 | 11.4 | 10.7 | 10.1 | 9.4 | |
| 4 | 23.3 | 21.8 | 20.4 | 19.2 | 18.1 | 17.1 | 15.5 | 14.1 | 13.0 | 12.0 | 11.2 | 10.5 | 9.8 | 9.3 | 8.5 | |
| 5 | 23.1 | 21.4 | 20.0 | 18.7 | 17.5 | 16.5 | 14.8 | 13.5 | 12.3 | 11.3 | 10.5 | 9.8 | 9.2 | - | - | |
| 10 | 22.4 | 20.2 | 18.4 | 16.9 | 15.6 | 14.5 | 12.7 | 11.3 | - | - | - | - | - | - | - | |
| 15 | 21.9 | 19.3 | 17.3 | 15.7 | 14.4 | 13.2 | - | - | - | - | - | - | - | - | - | |
| 30 | 20.7 | 17.7 | 15.4 | - | - | - | - | - | - | - | - | - | - | - | - | |
| 1 | 24.1 | 23.1 | 22.3 | 21.4 | 20.7 | 19.9 | 18.7 | 17.5 | 16.5 | 15.6 | 14.8 | 13.6 | 12.2 | 11.1 | 9.8 | 100 |
| 2 | 23.7 | 22.4 | 21.2 | 20.2 | 19.2 | 18.4 | 16.9 | 15.6 | 14.5 | 13.5 | 12.7 | 11.6 | 10.5 | 9.5 | 8.4 | |
| 3 | 23.4 | 21.9 | 20.5 | 19.3 | 18.3 | 17.3 | 15.7 | 14.3 | 13.2 | 12.2 | 11.4 | 10.7 | 9.9 | 9.0 | 7.9 | |
| 4 | 23.1 | 21.4 | 19.9 | 18.7 | 17.5 | 16.5 | 14.8 | 13.5 | 12.3 | 11.3 | 10.5 | 9.8 | 9.2 | 8.6 | 7.7 | |
| 5 | 22.9 | 21.1 | 19.5 | 18.1 | 16.9 | 15.9 | 14.1 | 12.8 | 11.6 | 10.7 | 9.8 | 9.1 | 8.5 | - | - | |
| 10 | 22.1 | 19.7 | 17.8 | 16.2 | 14.9 | 13.8 | 12.0 | 10.6 | - | - | - | - | - | - | - | |
| 15 | 21.5 | 18.8 | 16.7 | 15.0 | 13.7 | 12.5 | - | - | - | - | - | - | - | - | - | |
| 30 | 20.3 | 17.1 | 14.7 | - | - | - | - | - | - | - | - | - | - | - | - | |
| 1 | 23.9 | 22.7 | 21.7 | 20.7 | 19.9 | 19.1 | 17.6 | 16.4 | 15.3 | 13.4 | 11.7 | 10.4 | 9.4 | 8.5 | 7.5 | 150 |
| 2 | 23.4 | 21.9 | 20.5 | 19.3 | 18.3 | 17.3 | 15.7 | 14.3 | 12.6 | 10.8 | 9.5 | 8.4 | 7.6 | 6.9 | 6.1 | |
| 3 | 23.0 | 21.2 | 19.7 | 18.4 | 17.2 | 16.2 | 14.5 | 13.1 | 11.6 | 10.0 | 8.7 | 7.8 | 7.0 | 6.3 | 5.6 | |
| 4 | 22.7 | 20.7 | 19.1 | 17.6 | 16.4 | 15.3 | 13.6 | 12.2 | 11.0 | 9.5 | 8.3 | 7.4 | 6.7 | 6.1 | 5.3 | |
| 5 | 22.5 | 20.3 | 18.5 | 17.0 | 15.8 | 14.7 | 12.9 | 11.5 | 10.4 | 9.3 | 8.1 | 7.2 | 6.5 | - | - | |
| 10 | 21.5 | 18.8 | 16.7 | 15.0 | 13.7 | 12.5 | 10.7 | 9.4 | - | - | - | - | - | - | - | |
| 15 | 20.9 | 17.8 | 15.5 | 13.8 | 12.4 | 11.2 | - | - | - | - | - | - | - | - | - | |
| 30 | 19.5 | 15.9 | 13.4 | - | - | - | - | - | - | - | - | - | - | - | - | |
| 1 | 23.4 | 21.9 | 20.5 | 19.3 | 18.3 | 17.3 | 15.7 | 12.9 | 10.8 | 9.2 | 8.1 | 7.2 | 6.5 | 5.9 | 5.2 | 300 |
| 2 | 22.7 | 20.7 | 19.1 | 17.6 | 16.4 | 15.3 | 11.7 | 9.4 | 7.8 | 6.7 | 5.8 | 5.2 | 4.7 | 4.3 | 3.7 | |
| 3 | 22.3 | 19.9 | 18.1 | 16.5 | 15.2 | 13.6 | 10.2 | 8.2 | 6.8 | 5.8 | 5.1 | 4.5 | 4.1 | 3.7 | 3.3 | |
| 4 | 21.9 | 19.3 | 17.3 | 15.7 | 14.3 | 12.6 | 9.5 | 7.6 | 6.3 | 5.4 | 4.7 | 4.2 | 3.8 | 3.4 | 3.0 | |
| 5 | 21.5 | 18.8 | 16.7 | 15.0 | 13.7 | 12.0 | 9.0 | 7.2 | 6.0 | 5.2 | 4.5 | 4.0 | 3.6 | - | - | |
| 10 | 20.3 | 17.0 | 14.7 | 12.9 | 11.5 | 10.4 | 8.1 | 6.5 | - | - | - | - | - | - | - | |
| 15 | 19.5 | 15.9 | 13.4 | 11.6 | 10.2 | 9.1 | - | - | - | - | - | - | - | - | - | |
| 30 | 17.8 | 13.8 | 11.2 | - | - | - | - | - | - | - | - | - | - | - | - | |



Abaco per carichi in serie - Serial load rating - Abaque de charges successives

▣ **0.6 - 1 ~ - 10000 min⁻¹**

| Potenza ammessa sul tubo in kW, per serie di n esposizioni, con frequenza z e durata di ogni esposizione in sec | | | | | | | | | | | | | | | n | |
|--|-------|-------|-------|-------|-------|-------|-------|-------|-------|-------|-------|-------|-------|-------|-------|-----|
| Anode input power as a function of n (N° of exposures in series), z (exp. rate per sec), the exposure time (sec) | | | | | | | | | | | | | | | | |
| Puissance anodique en fonction de n (N° d'exp. de la séries), z (cadence d'exp. par sec), temps d'exposition (sec) | | | | | | | | | | | | | | | | |
| z | 0.010 | 0.020 | 0.030 | 0.040 | 0.050 | 0.060 | 0.080 | 0.100 | 0.120 | 0.140 | 0.160 | 0.180 | 0.200 | 0.220 | 0.250 | |
| 1 | 23.0 | 22.4 | 22.0 | 21.7 | 21.5 | 21.2 | 20.9 | 20.5 | 20.3 | 20.0 | 19.8 | 19.6 | 19.3 | 19.0 | 18.5 | 5 |
| 2 | 23.0 | 22.4 | 22.0 | 21.7 | 21.5 | 21.2 | 20.9 | 20.5 | 19.9 | 19.4 | 18.9 | 18.4 | 18.0 | 17.5 | 16.9 | |
| 3 | 23.0 | 22.4 | 22.0 | 21.7 | 21.5 | 21.2 | 20.5 | 19.8 | 19.2 | 18.6 | 18.0 | 17.5 | 17.0 | 16.6 | 15.9 | |
| 4 | 23.0 | 22.4 | 22.0 | 21.7 | 21.3 | 20.9 | 20.1 | 19.3 | 18.7 | 18.0 | 17.4 | 16.8 | 16.3 | 15.8 | 15.1 | |
| 5 | 23.0 | 22.4 | 22.0 | 21.6 | 21.1 | 20.6 | 19.7 | 18.9 | 18.2 | 17.5 | 16.9 | 16.3 | 15.7 | - | - | |
| 10 | 22.9 | 22.2 | 21.5 | 20.8 | 20.1 | 19.5 | 18.5 | 17.5 | - | - | - | - | - | - | - | |
| 15 | 22.8 | 21.9 | 21.0 | 20.2 | 19.5 | 18.8 | - | - | - | - | - | - | - | - | - | |
| 30 | 22.4 | 21.2 | 20.1 | - | - | - | - | - | - | - | - | - | - | - | - | |
| 1 | 23.0 | 22.4 | 22.0 | 21.7 | 21.5 | 21.2 | 20.9 | 20.5 | 19.9 | 19.4 | 18.9 | 18.4 | 18.0 | 17.5 | 16.9 | 10 |
| 2 | 23.0 | 22.4 | 22.0 | 21.7 | 21.3 | 20.9 | 20.1 | 19.3 | 18.6 | 18.0 | 17.4 | 16.8 | 16.3 | 15.8 | 15.1 | |
| 3 | 23.0 | 22.4 | 21.9 | 21.4 | 20.8 | 20.3 | 19.4 | 18.6 | 17.8 | 17.1 | 16.4 | 15.8 | 15.2 | 14.7 | 14.0 | |
| 4 | 23.0 | 22.3 | 21.7 | 21.0 | 20.5 | 19.9 | 18.9 | 18.0 | 17.1 | 16.4 | 15.7 | 15.0 | 14.4 | 13.9 | 13.1 | |
| 5 | 22.9 | 22.2 | 21.4 | 20.8 | 20.1 | 19.5 | 18.4 | 17.5 | 16.6 | 15.8 | 15.1 | 14.4 | 13.8 | - | - | |
| 10 | 22.6 | 21.6 | 20.6 | 19.7 | 18.9 | 18.2 | 16.9 | 15.7 | - | - | - | - | - | - | - | |
| 15 | 22.4 | 21.1 | 20.0 | 19.0 | 18.1 | 17.3 | - | - | - | - | - | - | - | - | - | |
| 30 | 21.9 | 20.2 | 18.8 | - | - | - | - | - | - | - | - | - | - | - | - | |
| 1 | 23.0 | 22.4 | 22.0 | 21.7 | 21.3 | 20.9 | 20.1 | 19.3 | 18.6 | 18.0 | 17.4 | 16.8 | 16.3 | 15.8 | 15.1 | 20 |
| 2 | 23.0 | 22.3 | 21.7 | 21.0 | 20.5 | 19.9 | 18.9 | 18.0 | 17.1 | 16.4 | 15.7 | 15.0 | 14.4 | 13.9 | 13.1 | |
| 3 | 22.9 | 22.0 | 21.2 | 20.5 | 19.8 | 19.2 | 18.0 | 17.0 | 16.1 | 15.3 | 14.5 | 13.9 | 13.2 | 12.7 | 11.9 | |
| 4 | 22.7 | 21.8 | 20.9 | 20.1 | 19.3 | 18.6 | 17.4 | 16.3 | 15.3 | 14.5 | 13.7 | 13.0 | 12.4 | 11.8 | 11.1 | |
| 5 | 22.6 | 21.6 | 20.6 | 19.7 | 18.9 | 18.2 | 16.9 | 15.7 | 14.7 | 13.8 | 13.1 | 12.4 | 11.7 | - | - | |
| 10 | 22.2 | 20.8 | 19.5 | 18.4 | 17.5 | 16.6 | 15.1 | 13.8 | - | - | - | - | - | - | - | |
| 15 | 21.8 | 20.2 | 18.8 | 17.6 | 16.5 | 15.5 | - | - | - | - | - | - | - | - | - | |
| 30 | 21.1 | 19.0 | 17.3 | - | - | - | - | - | - | - | - | - | - | - | - | |
| 1 | 23.0 | 22.3 | 21.7 | 21.0 | 20.5 | 19.9 | 18.9 | 18.0 | 17.1 | 16.3 | 15.7 | 15.0 | 14.4 | 13.9 | 13.1 | 40 |
| 2 | 22.7 | 21.8 | 20.9 | 20.1 | 19.3 | 18.6 | 17.4 | 16.3 | 15.3 | 14.5 | 13.7 | 13.0 | 12.4 | 11.8 | 11.1 | |
| 3 | 22.5 | 21.4 | 20.3 | 19.4 | 18.6 | 17.8 | 16.4 | 15.2 | 14.2 | 13.3 | 12.5 | 11.8 | 11.2 | 10.6 | 9.9 | |
| 4 | 22.3 | 21.0 | 19.9 | 18.9 | 18.0 | 17.1 | 15.7 | 14.4 | 13.4 | 12.5 | 11.7 | 11.0 | 10.3 | 9.8 | 9.1 | |
| 5 | 22.2 | 20.8 | 19.5 | 18.4 | 17.4 | 16.6 | 15.0 | 13.8 | 12.7 | 11.8 | 11.0 | 10.3 | 9.7 | - | - | |
| 10 | 21.6 | 19.7 | 18.2 | 16.9 | 15.7 | 14.7 | 13.1 | 11.7 | - | - | - | - | - | - | - | |
| 15 | 21.1 | 19.0 | 17.3 | 15.8 | 14.6 | 13.6 | - | - | - | - | - | - | - | - | - | |
| 30 | 20.2 | 17.6 | 15.5 | - | - | - | - | - | - | - | - | - | - | - | - | |
| 1 | 22.9 | 22.0 | 21.2 | 20.5 | 19.8 | 19.2 | 18.0 | 17.0 | 16.1 | 15.3 | 14.5 | 13.9 | 13.2 | 12.7 | 11.9 | 60 |
| 2 | 22.5 | 21.4 | 20.3 | 19.4 | 18.6 | 17.8 | 16.4 | 15.2 | 14.2 | 13.3 | 12.5 | 11.8 | 11.2 | 10.6 | 9.9 | |
| 3 | 22.2 | 20.9 | 19.7 | 18.6 | 17.7 | 16.8 | 15.3 | 14.1 | 13.0 | 12.1 | 11.3 | 10.6 | 10.0 | 9.5 | 8.7 | |
| 4 | 22.0 | 20.5 | 19.2 | 18.0 | 17.0 | 16.1 | 14.5 | 13.2 | 12.2 | 11.3 | 10.5 | 9.8 | 9.2 | 8.7 | 8.0 | |
| 5 | 21.8 | 20.2 | 18.8 | 17.5 | 16.5 | 15.5 | 13.9 | 12.6 | 11.5 | 10.6 | 9.8 | 9.1 | 8.6 | - | - | |
| 10 | 21.1 | 19.0 | 17.3 | 15.8 | 14.6 | 13.6 | 11.9 | 10.5 | - | - | - | - | - | - | - | |
| 15 | 20.6 | 18.2 | 16.3 | 14.7 | 13.4 | 12.4 | - | - | - | - | - | - | - | - | - | |
| 30 | 19.5 | 16.6 | 14.4 | - | - | - | - | - | - | - | - | - | - | - | - | |
| 1 | 22.7 | 21.8 | 20.9 | 20.1 | 19.3 | 18.6 | 17.4 | 16.3 | 15.3 | 14.5 | 13.7 | 13.0 | 12.4 | 11.8 | 11.1 | 80 |
| 2 | 22.3 | 21.0 | 19.9 | 18.9 | 18.0 | 17.1 | 15.7 | 14.4 | 13.4 | 12.5 | 11.7 | 11.0 | 10.3 | 9.8 | 9.1 | |
| 3 | 22.0 | 20.5 | 19.2 | 18.0 | 17.0 | 16.1 | 14.5 | 13.2 | 12.2 | 11.3 | 10.5 | 9.8 | 9.2 | 8.7 | 8.0 | |
| 4 | 21.8 | 20.1 | 18.6 | 17.4 | 16.3 | 15.3 | 13.7 | 12.4 | 11.3 | 10.4 | 9.6 | 9.0 | 8.4 | 7.9 | 7.2 | |
| 5 | 21.6 | 19.7 | 18.2 | 16.9 | 15.7 | 14.7 | 13.1 | 11.7 | 10.7 | 9.8 | 9.0 | 8.4 | 7.8 | - | - | |
| 10 | 20.8 | 18.4 | 16.6 | 15.0 | 13.8 | 12.7 | 11.0 | 9.7 | - | - | - | - | - | - | - | |
| 15 | 20.2 | 17.5 | 15.5 | 13.9 | 12.6 | 11.5 | - | - | - | - | - | - | - | - | - | |
| 30 | 19.0 | 15.8 | 13.6 | - | - | - | - | - | - | - | - | - | - | - | - | |
| 1 | 22.6 | 21.6 | 20.6 | 19.7 | 18.9 | 18.2 | 16.9 | 15.7 | 14.7 | 13.8 | 13.1 | 12.4 | 11.7 | 11.1 | 9.8 | 100 |
| 2 | 22.2 | 20.8 | 19.5 | 18.4 | 17.4 | 16.6 | 15.0 | 13.8 | 12.7 | 11.8 | 11.0 | 10.3 | 9.7 | 9.2 | 8.4 | |
| 3 | 21.8 | 20.2 | 18.8 | 17.5 | 16.5 | 15.5 | 13.9 | 12.6 | 11.5 | 10.6 | 9.8 | 9.1 | 8.6 | 8.0 | 7.4 | |
| 4 | 21.6 | 19.7 | 18.2 | 16.9 | 15.7 | 14.7 | 13.1 | 11.7 | 10.7 | 9.8 | 9.0 | 8.4 | 7.8 | 7.3 | 6.7 | |
| 5 | 21.3 | 19.3 | 17.7 | 16.3 | 15.1 | 14.1 | 12.4 | 11.1 | 10.0 | 9.1 | 8.4 | 7.8 | 7.2 | - | - | |
| 10 | 20.5 | 18.0 | 16.0 | 14.4 | 13.1 | 12.0 | 10.3 | 9.1 | - | - | - | - | - | - | - | |
| 15 | 19.8 | 17.0 | 14.9 | 13.2 | 11.9 | 10.8 | - | - | - | - | - | - | - | - | - | |
| 30 | 18.6 | 15.2 | 12.9 | - | - | - | - | - | - | - | - | - | - | - | - | |
| 1 | 22.4 | 21.1 | 20.0 | 19.0 | 18.1 | 17.3 | 15.8 | 14.6 | 13.6 | 12.6 | 11.7 | 10.4 | 9.4 | 8.5 | 7.5 | 150 |
| 2 | 21.8 | 20.2 | 18.8 | 17.5 | 16.5 | 15.5 | 13.9 | 12.6 | 11.5 | 10.6 | 9.5 | 8.4 | 7.6 | 6.9 | 6.1 | |
| 3 | 21.4 | 19.5 | 17.9 | 16.6 | 15.4 | 14.4 | 12.7 | 11.4 | 10.3 | 9.4 | 8.7 | 7.8 | 7.0 | 6.3 | 5.6 | |
| 4 | 21.1 | 19.0 | 17.3 | 15.8 | 14.6 | 13.6 | 11.9 | 10.5 | 9.5 | 8.6 | 7.9 | 7.3 | 6.7 | 6.1 | 5.3 | |
| 5 | 20.8 | 18.6 | 16.7 | 15.2 | 14.0 | 12.9 | 11.2 | 9.9 | 8.9 | 8.0 | 7.3 | 6.7 | 6.2 | - | - | |
| 10 | 19.8 | 17.0 | 14.9 | 13.2 | 11.9 | 10.8 | 9.2 | 8.0 | - | - | - | - | - | - | - | |
| 15 | 19.1 | 16.0 | 13.7 | 12.0 | 10.7 | 9.7 | - | - | - | - | - | - | - | - | - | |
| 30 | 17.7 | 14.1 | 11.7 | - | - | - | - | - | - | - | - | - | - | - | - | |
| 1 | 21.8 | 20.2 | 18.8 | 17.5 | 16.5 | 15.5 | 13.9 | 12.6 | 10.8 | 9.2 | 8.1 | 7.2 | 6.5 | 5.9 | 5.2 | 300 |
| 2 | 21.1 | 19.0 | 17.3 | 15.8 | 14.6 | 13.6 | 11.7 | 9.4 | 7.8 | 6.7 | 5.8 | 5.2 | 4.7 | 4.3 | 3.7 | |
| 3 | 20.6 | 18.2 | 16.3 | 14.7 | 13.4 | 12.4 | 10.2 | 8.2 | 6.8 | 5.8 | 5.1 | 4.5 | 4.1 | 3.7 | 3.3 | |
| 4 | 20.2 | 17.5 | 15.5 | 13.9 | 12.6 | 11.5 | 9.5 | 7.6 | 6.3 | 5.4 | 4.7 | 4.2 | 3.8 | 3.4 | 3.0 | |
| 5 | 19.8 | 17.0 | 14.9 | 13.2 | 11.9 | 10.8 | 9.0 | 7.2 | 6.0 | 5.2 | 4.5 | 4.0 | 3.6 | - | - | |
| 10 | 18.6 | 15.2 | 12.9 | 11.2 | 9.9 | 8.9 | 7.3 | 6.2 | - | - | - | - | - | - | - | |
| 15 | 17.7 | 14.1 | 11.7 | 10.0 | 8.7 | 7.8 | - | - | - | - | - | - | - | - | - | |
| 30 | 16.0 | 12.0 | 9.7 | - | - | - | - | - | - | - | - | - | - | - | - | |



Abaco per carichi in serie - Serial load rating - Abaque de charges successives
 ■ 1.0 - 1 ~ - 10000 min⁻¹

| Potenza ammessa sul tubo in kW, per serie di n esposizioni, con frequenza z e durata di ogni esposizione in sec | | | | | | | | | | | | | | | n | |
|---|-------|-------|-------|-------|-------|-------|-------|-------|-------|-------|-------|-------|-------|-------|-------|-----|
| Anode input power as a function of n (N° of exposures in series), z (exp. rate per sec), the exposure time (sec) | | | | | | | | | | | | | | | | |
| Puissance anodique en fonction de n (N° d'exp. de la série), z (cadence d'exp. par sec), temps d'exposition (sec) | | | | | | | | | | | | | | | | |
| z | 0.010 | 0.020 | 0.030 | 0.040 | 0.050 | 0.060 | 0.080 | 0.100 | 0.120 | 0.140 | 0.160 | 0.180 | 0.200 | 0.220 | 0.250 | |
| 1 | 39.8 | 38.4 | 37.6 | 36.9 | 36.4 | 35.9 | 35.1 | 34.5 | 33.9 | 33.4 | 32.9 | 32.5 | 32.0 | 31.3 | 30.3 | 5 |
| 2 | 39.8 | 38.4 | 37.6 | 36.9 | 36.4 | 35.9 | 35.1 | 34.3 | 33.1 | 32.1 | 31.1 | 30.1 | 29.2 | 28.4 | 27.2 | |
| 3 | 39.8 | 38.4 | 37.6 | 36.9 | 36.4 | 35.9 | 34.4 | 33.0 | 31.7 | 30.5 | 29.4 | 28.4 | 27.4 | 26.5 | 25.3 | |
| 4 | 39.8 | 38.4 | 37.6 | 36.9 | 36.1 | 35.2 | 33.5 | 32.0 | 30.6 | 29.3 | 28.1 | 27.1 | 26.1 | 25.1 | 23.8 | |
| 5 | 39.8 | 38.4 | 37.6 | 36.6 | 35.6 | 34.6 | 32.8 | 31.2 | 29.7 | 28.4 | 27.1 | 26.0 | 25.0 | - | - | |
| 10 | 39.6 | 37.9 | 36.4 | 34.9 | 33.6 | 32.4 | 30.2 | 28.3 | - | - | - | - | - | - | - | |
| 15 | 39.2 | 37.2 | 35.4 | 33.8 | 32.3 | 30.9 | - | - | - | - | - | - | - | - | - | |
| 30 | 38.4 | 35.8 | 33.5 | - | - | - | - | - | - | - | - | - | - | - | - | |
| 1 | 39.8 | 38.4 | 37.6 | 36.9 | 36.4 | 35.9 | 35.1 | 34.3 | 33.1 | 32.1 | 31.1 | 30.1 | 29.2 | 28.4 | 27.2 | 10 |
| 2 | 39.8 | 38.4 | 37.6 | 36.9 | 36.1 | 35.2 | 33.5 | 32.0 | 30.6 | 29.3 | 28.1 | 27.0 | 26.0 | 25.1 | 23.8 | |
| 3 | 39.8 | 38.4 | 37.4 | 36.2 | 35.1 | 34.1 | 32.1 | 30.4 | 28.9 | 27.5 | 26.2 | 25.1 | 24.0 | 23.1 | 21.7 | |
| 4 | 39.8 | 38.3 | 36.8 | 35.5 | 34.3 | 33.1 | 31.1 | 29.2 | 27.6 | 26.1 | 24.8 | 23.6 | 22.6 | 21.6 | 20.3 | |
| 5 | 39.6 | 37.9 | 36.4 | 34.9 | 33.6 | 32.4 | 30.2 | 28.2 | 26.6 | 25.1 | 23.7 | 22.5 | 21.4 | - | - | |
| 10 | 38.9 | 36.6 | 34.6 | 32.8 | 31.2 | 29.7 | 27.1 | 25.0 | - | - | - | - | - | - | - | |
| 15 | 38.4 | 35.7 | 33.4 | 31.3 | 29.5 | 27.9 | - | - | - | - | - | - | - | - | - | |
| 30 | 37.2 | 33.8 | 30.9 | - | - | - | - | - | - | - | - | - | - | - | - | |
| 1 | 39.8 | 38.4 | 37.6 | 36.9 | 36.1 | 35.2 | 33.5 | 32.0 | 30.6 | 29.3 | 28.1 | 27.0 | 26.0 | 25.1 | 23.8 | 20 |
| 2 | 39.8 | 38.3 | 36.8 | 35.5 | 34.3 | 33.1 | 31.1 | 29.2 | 27.6 | 26.1 | 24.8 | 23.6 | 22.6 | 21.6 | 20.3 | |
| 3 | 39.4 | 37.6 | 35.9 | 34.4 | 33.0 | 31.7 | 29.4 | 27.4 | 25.7 | 24.1 | 22.8 | 21.6 | 20.5 | 19.5 | 18.2 | |
| 4 | 39.1 | 37.1 | 35.2 | 33.5 | 32.0 | 30.6 | 28.1 | 26.0 | 24.2 | 22.7 | 21.3 | 20.1 | 19.0 | 18.0 | 16.7 | |
| 5 | 38.9 | 36.6 | 34.6 | 32.8 | 31.1 | 29.7 | 27.1 | 24.9 | 23.1 | 21.5 | 20.1 | 18.9 | 17.8 | - | - | |
| 10 | 37.9 | 34.9 | 32.4 | 30.2 | 28.2 | 26.6 | 23.7 | 21.4 | - | - | - | - | - | - | - | |
| 15 | 37.2 | 33.7 | 30.9 | 28.4 | 26.4 | 24.6 | - | - | - | - | - | - | - | - | - | |
| 30 | 35.7 | 31.3 | 27.9 | - | - | - | - | - | - | - | - | - | - | - | - | |
| 1 | 39.8 | 38.3 | 36.8 | 35.5 | 34.3 | 33.1 | 31.1 | 29.2 | 27.6 | 26.1 | 24.8 | 23.6 | 22.6 | 21.6 | 20.2 | 40 |
| 2 | 39.1 | 37.1 | 35.2 | 33.5 | 32.0 | 30.6 | 28.1 | 26.0 | 24.2 | 22.7 | 21.3 | 20.1 | 19.0 | 18.0 | 16.7 | |
| 3 | 38.7 | 36.2 | 34.0 | 32.1 | 30.4 | 28.9 | 26.2 | 24.0 | 22.2 | 20.6 | 19.2 | 18.0 | 16.9 | 16.0 | 14.7 | |
| 4 | 38.3 | 35.5 | 33.1 | 31.1 | 29.2 | 27.6 | 24.8 | 22.6 | 20.7 | 19.1 | 17.7 | 16.5 | 15.5 | 14.6 | 13.4 | |
| 5 | 37.9 | 34.9 | 32.4 | 30.2 | 28.2 | 26.5 | 23.7 | 21.4 | 19.5 | 17.9 | 16.6 | 15.4 | 14.4 | - | - | |
| 10 | 36.6 | 32.8 | 29.7 | 27.1 | 24.9 | 23.1 | 20.1 | 17.8 | - | - | - | - | - | - | - | |
| 15 | 35.7 | 31.3 | 27.9 | 25.2 | 22.9 | 21.0 | - | - | - | - | - | - | - | - | - | |
| 30 | 33.7 | 28.4 | 24.6 | - | - | - | - | - | - | - | - | - | - | - | - | |
| 1 | 39.4 | 37.6 | 35.9 | 34.4 | 33.0 | 31.7 | 29.4 | 27.4 | 25.7 | 24.1 | 22.5 | 20.0 | 18.0 | 16.4 | 14.4 | 60 |
| 2 | 38.7 | 36.2 | 34.0 | 32.1 | 30.4 | 28.9 | 26.2 | 24.0 | 22.2 | 20.6 | 19.2 | 18.0 | 16.3 | 14.8 | 13.0 | |
| 3 | 38.1 | 35.2 | 32.7 | 30.6 | 28.7 | 27.0 | 24.2 | 22.0 | 20.1 | 18.5 | 17.1 | 15.9 | 14.9 | 14.0 | 12.5 | |
| 4 | 37.6 | 34.4 | 31.7 | 29.4 | 27.4 | 25.7 | 22.8 | 20.5 | 18.6 | 17.0 | 15.7 | 14.6 | 13.6 | 12.7 | 11.6 | |
| 5 | 37.2 | 33.7 | 30.8 | 28.4 | 26.3 | 24.6 | 21.6 | 19.3 | 17.4 | 15.9 | 14.6 | 13.5 | 12.6 | - | - | |
| 10 | 35.7 | 31.3 | 27.9 | 25.1 | 22.9 | 21.0 | 18.0 | 15.8 | - | - | - | - | - | - | - | |
| 15 | 34.6 | 29.7 | 26.0 | 23.1 | 20.8 | 18.9 | - | - | - | - | - | - | - | - | - | |
| 30 | 32.4 | 26.6 | 22.5 | - | - | - | - | - | - | - | - | - | - | - | - | |
| 1 | 39.1 | 37.1 | 35.2 | 33.5 | 32.0 | 30.6 | 28.1 | 26.0 | 24.0 | 20.6 | 18.0 | 16.0 | 14.4 | 13.1 | 11.5 | 80 |
| 2 | 38.3 | 35.5 | 33.1 | 31.1 | 29.2 | 27.6 | 24.8 | 22.6 | 20.7 | 18.0 | 15.8 | 14.0 | 12.6 | 11.5 | 10.1 | |
| 3 | 37.6 | 34.4 | 31.7 | 29.4 | 27.4 | 25.7 | 22.8 | 20.5 | 18.6 | 17.0 | 15.0 | 13.4 | 12.0 | 10.9 | 9.6 | |
| 4 | 37.1 | 33.5 | 30.6 | 28.1 | 26.0 | 24.2 | 21.3 | 19.0 | 17.1 | 15.6 | 14.3 | 13.0 | 11.7 | 10.7 | 9.4 | |
| 5 | 36.6 | 32.8 | 29.7 | 27.1 | 24.9 | 23.1 | 20.1 | 17.8 | 16.0 | 14.5 | 13.3 | 12.3 | 11.4 | - | - | |
| 10 | 34.9 | 30.2 | 26.5 | 23.7 | 21.4 | 19.5 | 16.6 | 14.4 | - | - | - | - | - | - | - | |
| 15 | 33.7 | 28.4 | 24.6 | 21.6 | 19.3 | 17.4 | - | - | - | - | - | - | - | - | - | |
| 30 | 31.3 | 25.2 | 21.0 | - | - | - | - | - | - | - | - | - | - | - | - | |
| 1 | 38.9 | 36.6 | 34.6 | 32.8 | 31.1 | 29.7 | 27.1 | 24.5 | 20.4 | 17.5 | 15.3 | 13.6 | 12.2 | 11.1 | 9.8 | 100 |
| 2 | 37.9 | 34.9 | 32.4 | 30.2 | 28.2 | 26.5 | 23.7 | 20.9 | 17.4 | 14.9 | 13.1 | 11.6 | 10.5 | 9.5 | 8.4 | |
| 3 | 37.2 | 33.7 | 30.8 | 28.4 | 26.3 | 24.6 | 21.6 | 19.3 | 16.4 | 14.1 | 12.3 | 11.0 | 9.9 | 9.0 | 7.9 | |
| 4 | 36.6 | 32.8 | 29.7 | 27.1 | 24.9 | 23.1 | 20.1 | 17.8 | 16.0 | 13.7 | 12.0 | 10.6 | 9.6 | 8.7 | 7.7 | |
| 5 | 36.1 | 32.0 | 28.7 | 26.0 | 23.8 | 22.0 | 19.0 | 16.7 | 14.9 | 13.4 | 11.7 | 10.4 | 9.4 | - | - | |
| 10 | 34.3 | 29.2 | 25.5 | 22.6 | 20.3 | 18.4 | 15.5 | 13.4 | - | - | - | - | - | - | - | |
| 15 | 33.0 | 27.4 | 23.4 | 20.5 | 18.2 | 16.3 | - | - | - | - | - | - | - | - | - | |
| 30 | 30.4 | 24.0 | 19.9 | - | - | - | - | - | - | - | - | - | - | - | - | |
| 1 | 38.3 | 35.7 | 33.3 | 31.3 | 29.5 | 27.9 | 23.4 | 18.7 | 15.6 | 13.4 | 11.7 | 10.4 | 9.4 | 8.5 | 7.5 | 150 |
| 2 | 37.2 | 33.7 | 30.8 | 28.4 | 26.3 | 24.6 | 18.9 | 15.1 | 12.6 | 10.8 | 9.5 | 8.4 | 7.6 | 6.9 | 6.1 | |
| 3 | 36.3 | 32.4 | 29.2 | 26.5 | 24.4 | 22.5 | 17.4 | 14.0 | 11.6 | 10.0 | 8.7 | 7.8 | 7.0 | 6.3 | 5.6 | |
| 4 | 35.7 | 31.3 | 27.9 | 25.1 | 22.9 | 21.0 | 16.7 | 13.4 | 11.1 | 9.5 | 8.3 | 7.4 | 6.7 | 6.1 | 5.3 | |
| 5 | 35.1 | 30.4 | 26.8 | 24.0 | 21.7 | 19.9 | 16.3 | 13.0 | 10.8 | 9.3 | 8.1 | 7.2 | 6.5 | - | - | |
| 10 | 33.0 | 27.4 | 23.4 | 20.5 | 18.2 | 16.3 | 13.6 | 11.6 | - | - | - | - | - | - | - | |
| 15 | 31.5 | 25.5 | 21.3 | 18.4 | 16.1 | 14.4 | - | - | - | - | - | - | - | - | - | |
| 30 | 28.7 | 22.0 | 17.8 | - | - | - | - | - | - | - | - | - | - | - | - | |
| 1 | 37.2 | 33.7 | 30.8 | 28.4 | 25.9 | 21.5 | 16.2 | 12.9 | 10.8 | 9.2 | 8.1 | 7.2 | 6.5 | 5.9 | 5.2 | 300 |
| 2 | 35.7 | 31.3 | 27.9 | 23.4 | 18.7 | 15.6 | 11.7 | 9.4 | 7.8 | 6.7 | 5.8 | 5.2 | 4.7 | 4.3 | 3.7 | |
| 3 | 34.6 | 29.7 | 26.0 | 20.4 | 16.3 | 13.6 | 10.2 | 8.2 | 6.8 | 5.8 | 5.1 | 4.5 | 4.1 | 3.7 | 3.3 | |
| 4 | 33.7 | 28.4 | 24.6 | 18.9 | 15.1 | 12.6 | 9.5 | 7.6 | 6.3 | 5.4 | 4.7 | 4.2 | 3.8 | 3.4 | 3.0 | |
| 5 | 33.0 | 27.4 | 23.4 | 18.0 | 14.4 | 12.0 | 9.0 | 7.2 | 6.0 | 5.2 | 4.5 | 4.0 | 3.6 | - | - | |
| 10 | 30.4 | 24.0 | 19.9 | 16.3 | 13.0 | 10.8 | 8.1 | 6.5 | - | - | - | - | - | - | - | |
| 15 | 28.7 | 22.0 | 17.8 | - | - | - | - | - | - | - | - | - | - | - | - | |
| 30 | 25.5 | 18.4 | 14.4 | - | - | - | - | - | - | - | - | - | - | - | - | |



Abaco per carichi in serie - Serial load rating - Abaque de charges successives

▣ **0.6 - 3 ~ - 10000 min⁻¹**

| Potenza ammessa sul tubo in kW, per serie di n esposizioni, con frequenza z e durata di ogni esposizione in sec | | | | | | | | | | | | | | | n | |
|--|-------|-------|-------|-------|-------|-------|-------|-------|-------|-------|-------|-------|-------|-------|-------|-----|
| Anode input power as a function of n (N° of exposures in series), z (exp. rate per sec), the exposure time (sec) | | | | | | | | | | | | | | | | |
| Puissance anodique en fonction de n (N° d'exp. de la séries), z (cadence d'exp. par sec), temps d'exposition (sec) | | | | | | | | | | | | | | | | |
| z | 0.010 | 0.020 | 0.030 | 0.040 | 0.050 | 0.060 | 0.080 | 0.100 | 0.120 | 0.140 | 0.160 | 0.180 | 0.200 | 0.220 | 0.250 | |
| 1 | 27.5 | 26.6 | 26.0 | 25.6 | 25.3 | 25.0 | 24.4 | 24.0 | 23.6 | 23.3 | 23.0 | 22.7 | 22.4 | 21.9 | 21.2 | 5 |
| 2 | 27.5 | 26.6 | 26.0 | 25.6 | 25.3 | 25.0 | 24.4 | 23.9 | 23.1 | 22.4 | 21.8 | 21.1 | 20.5 | 20.0 | 19.2 | |
| 3 | 27.5 | 26.6 | 26.0 | 25.6 | 25.3 | 25.0 | 24.0 | 23.0 | 22.2 | 21.4 | 20.7 | 20.0 | 19.3 | 18.7 | 17.9 | |
| 4 | 27.5 | 26.6 | 26.0 | 25.6 | 25.1 | 24.5 | 23.4 | 22.4 | 21.5 | 20.6 | 19.8 | 19.1 | 18.4 | 17.8 | 16.9 | |
| 5 | 27.5 | 26.6 | 26.0 | 25.4 | 24.7 | 24.1 | 22.9 | 21.8 | 20.9 | 20.0 | 19.1 | 18.4 | 17.7 | - | - | |
| 10 | 27.3 | 26.3 | 25.3 | 24.3 | 23.5 | 22.6 | 21.2 | 19.9 | - | - | - | - | - | - | - | |
| 15 | 27.1 | 25.8 | 24.6 | 23.6 | 22.6 | 21.7 | - | - | - | - | - | - | - | - | - | |
| 30 | 26.6 | 24.9 | 23.3 | - | - | - | - | - | - | - | - | - | - | - | - | |
| 1 | 27.5 | 26.6 | 26.0 | 25.6 | 25.3 | 25.0 | 24.4 | 23.9 | 23.1 | 22.4 | 21.8 | 21.1 | 20.5 | 20.0 | 19.2 | 10 |
| 2 | 27.5 | 26.6 | 26.0 | 25.6 | 25.1 | 24.5 | 23.4 | 22.4 | 21.4 | 20.6 | 19.8 | 19.1 | 18.4 | 17.8 | 16.9 | |
| 3 | 27.5 | 26.6 | 25.9 | 25.1 | 24.4 | 23.7 | 22.5 | 21.3 | 20.3 | 19.4 | 18.5 | 17.8 | 17.0 | 16.4 | 15.5 | |
| 4 | 27.5 | 26.5 | 25.5 | 24.7 | 23.9 | 23.1 | 21.8 | 20.5 | 19.5 | 18.5 | 17.6 | 16.8 | 16.0 | 15.4 | 14.5 | |
| 5 | 27.3 | 26.2 | 25.2 | 24.3 | 23.4 | 22.6 | 21.2 | 19.9 | 18.8 | 17.7 | 16.8 | 16.0 | 15.3 | - | - | |
| 10 | 26.9 | 25.4 | 24.1 | 22.9 | 21.8 | 20.9 | 19.1 | 17.7 | - | - | - | - | - | - | - | |
| 15 | 26.5 | 24.8 | 23.3 | 21.9 | 20.7 | 19.7 | - | - | - | - | - | - | - | - | - | |
| 30 | 25.8 | 23.6 | 21.7 | - | - | - | - | - | - | - | - | - | - | - | - | |
| 1 | 27.5 | 26.6 | 26.0 | 25.6 | 25.1 | 24.5 | 23.4 | 22.4 | 21.4 | 20.6 | 19.8 | 19.1 | 18.4 | 17.8 | 16.9 | 20 |
| 2 | 27.5 | 26.5 | 25.5 | 24.7 | 23.9 | 23.1 | 21.8 | 20.5 | 19.4 | 18.5 | 17.6 | 16.8 | 16.0 | 15.4 | 14.5 | |
| 3 | 27.2 | 26.0 | 25.0 | 24.0 | 23.0 | 22.2 | 20.7 | 19.3 | 18.1 | 17.1 | 16.2 | 15.4 | 14.6 | 13.9 | 13.0 | |
| 4 | 27.0 | 25.7 | 24.5 | 23.4 | 22.4 | 21.4 | 19.8 | 18.4 | 17.2 | 16.1 | 15.2 | 14.3 | 13.6 | 12.9 | 12.0 | |
| 5 | 26.9 | 25.4 | 24.1 | 22.9 | 21.8 | 20.8 | 19.1 | 17.7 | 16.4 | 15.3 | 14.4 | 13.5 | 12.8 | - | - | |
| 10 | 26.2 | 24.3 | 22.6 | 21.2 | 19.9 | 18.8 | 16.8 | 15.3 | - | - | - | - | - | - | - | |
| 15 | 25.8 | 23.5 | 21.6 | 20.0 | 18.6 | 17.4 | - | - | - | - | - | - | - | - | - | |
| 30 | 24.8 | 21.9 | 19.7 | - | - | - | - | - | - | - | - | - | - | - | - | |
| 1 | 27.5 | 26.5 | 25.5 | 24.7 | 23.9 | 23.1 | 21.8 | 20.5 | 19.4 | 18.5 | 17.6 | 16.8 | 16.0 | 15.4 | 14.5 | 40 |
| 2 | 27.0 | 25.7 | 24.5 | 23.4 | 22.4 | 21.4 | 19.8 | 18.4 | 17.2 | 16.1 | 15.2 | 14.3 | 13.6 | 12.9 | 12.0 | |
| 3 | 26.7 | 25.1 | 23.7 | 22.5 | 21.3 | 20.3 | 18.5 | 17.0 | 15.8 | 14.7 | 13.7 | 12.9 | 12.1 | 11.5 | 10.6 | |
| 4 | 26.5 | 24.7 | 23.1 | 21.8 | 20.5 | 19.4 | 17.6 | 16.0 | 14.8 | 13.7 | 12.7 | 11.9 | 11.2 | 10.5 | 9.7 | |
| 5 | 26.2 | 24.3 | 22.6 | 21.2 | 19.9 | 18.7 | 16.8 | 15.3 | 14.0 | 12.9 | 11.9 | 11.1 | 10.4 | - | - | |
| 10 | 25.4 | 22.9 | 20.8 | 19.1 | 17.7 | 16.4 | 14.4 | 12.8 | - | - | - | - | - | - | - | |
| 15 | 24.8 | 21.9 | 19.7 | 17.8 | 16.3 | 15.0 | - | - | - | - | - | - | - | - | - | |
| 30 | 23.5 | 20.0 | 17.4 | - | - | - | - | - | - | - | - | - | - | - | - | |
| 1 | 27.2 | 26.0 | 25.0 | 24.0 | 23.0 | 22.2 | 20.7 | 19.3 | 18.1 | 17.1 | 16.2 | 15.4 | 14.6 | 13.9 | 13.0 | 60 |
| 2 | 26.7 | 25.1 | 23.7 | 22.5 | 21.3 | 20.3 | 18.5 | 17.0 | 15.8 | 14.7 | 13.7 | 12.9 | 12.1 | 11.5 | 10.6 | |
| 3 | 26.4 | 24.5 | 22.9 | 21.4 | 20.2 | 19.1 | 17.2 | 15.6 | 14.3 | 13.2 | 12.3 | 11.5 | 10.8 | 10.1 | 9.3 | |
| 4 | 26.0 | 24.0 | 22.2 | 20.7 | 19.3 | 18.1 | 16.2 | 14.6 | 13.3 | 12.2 | 11.3 | 10.5 | 9.8 | 9.2 | 8.4 | |
| 5 | 25.8 | 23.5 | 21.6 | 20.0 | 18.6 | 17.4 | 15.4 | 13.8 | 12.5 | 11.4 | 10.5 | 9.8 | 9.1 | - | - | |
| 10 | 24.8 | 21.9 | 19.6 | 17.8 | 16.3 | 15.0 | 12.9 | 11.4 | - | - | - | - | - | - | - | |
| 15 | 24.1 | 20.8 | 18.4 | 16.4 | 14.8 | 13.5 | - | - | - | - | - | - | - | - | - | |
| 30 | 22.6 | 18.8 | 16.0 | - | - | - | - | - | - | - | - | - | - | - | - | |
| 1 | 27.0 | 25.7 | 24.5 | 23.4 | 22.4 | 21.4 | 19.8 | 18.4 | 17.2 | 16.1 | 15.2 | 14.3 | 13.6 | 12.9 | 11.5 | 80 |
| 2 | 26.5 | 24.7 | 23.1 | 21.8 | 20.5 | 19.4 | 17.6 | 16.0 | 14.7 | 13.7 | 12.7 | 11.9 | 11.2 | 10.5 | 9.7 | |
| 3 | 26.0 | 24.0 | 22.2 | 20.7 | 19.3 | 18.1 | 16.2 | 14.6 | 13.3 | 12.2 | 11.3 | 10.5 | 9.8 | 9.2 | 8.4 | |
| 4 | 25.7 | 23.4 | 21.4 | 19.8 | 18.4 | 17.2 | 15.2 | 13.6 | 12.3 | 11.2 | 10.3 | 9.6 | 8.9 | 8.3 | 7.6 | |
| 5 | 25.4 | 22.9 | 20.8 | 19.1 | 17.7 | 16.4 | 14.4 | 12.8 | 11.5 | 10.5 | 9.6 | 8.9 | 8.2 | - | - | |
| 10 | 24.3 | 21.2 | 18.7 | 16.8 | 15.3 | 14.0 | 11.9 | 10.4 | - | - | - | - | - | - | - | |
| 15 | 23.5 | 20.0 | 17.4 | 15.4 | 13.8 | 12.5 | - | - | - | - | - | - | - | - | - | |
| 30 | 21.9 | 17.8 | 15.0 | - | - | - | - | - | - | - | - | - | - | - | - | |
| 1 | 26.9 | 25.4 | 24.1 | 22.9 | 21.8 | 20.8 | 19.1 | 17.7 | 16.4 | 15.3 | 14.4 | 13.5 | 12.2 | 11.1 | 9.8 | 100 |
| 2 | 26.2 | 24.3 | 22.6 | 21.2 | 19.9 | 18.7 | 16.8 | 15.3 | 14.0 | 12.9 | 11.9 | 11.1 | 10.4 | 9.5 | 8.4 | |
| 3 | 25.8 | 23.5 | 21.6 | 20.0 | 18.6 | 17.4 | 15.4 | 13.8 | 12.5 | 11.4 | 10.5 | 9.8 | 9.1 | 8.5 | 7.8 | |
| 4 | 25.4 | 22.9 | 20.8 | 19.1 | 17.7 | 16.4 | 14.4 | 12.8 | 11.5 | 10.5 | 9.6 | 8.9 | 8.2 | 7.7 | 7.0 | |
| 5 | 25.1 | 22.4 | 20.2 | 18.4 | 16.9 | 15.6 | 13.6 | 12.0 | 10.8 | 9.7 | 8.9 | 8.2 | 7.6 | - | - | |
| 10 | 23.9 | 20.5 | 18.0 | 16.0 | 14.5 | 13.2 | 11.2 | 9.7 | - | - | - | - | - | - | - | |
| 15 | 23.0 | 19.3 | 16.6 | 14.6 | 13.0 | 11.7 | - | - | - | - | - | - | - | - | - | |
| 30 | 21.3 | 17.0 | 14.2 | - | - | - | - | - | - | - | - | - | - | - | - | |
| 1 | 26.5 | 24.8 | 23.3 | 21.9 | 20.7 | 19.6 | 17.8 | 16.3 | 15.0 | 13.4 | 11.7 | 10.4 | 9.4 | 8.5 | 7.5 | 150 |
| 2 | 25.8 | 23.5 | 21.6 | 20.0 | 18.6 | 17.4 | 15.4 | 13.8 | 12.5 | 10.8 | 9.5 | 8.4 | 7.6 | 6.9 | 6.1 | |
| 3 | 25.2 | 22.6 | 20.5 | 18.7 | 17.3 | 16.0 | 14.0 | 12.4 | 11.1 | 10.0 | 8.7 | 7.8 | 7.0 | 6.3 | 5.6 | |
| 4 | 24.8 | 21.9 | 19.6 | 17.8 | 16.3 | 15.0 | 12.9 | 11.4 | 10.2 | 9.2 | 8.3 | 7.4 | 6.7 | 6.1 | 5.3 | |
| 5 | 24.4 | 21.3 | 18.9 | 17.0 | 15.5 | 14.2 | 12.1 | 10.6 | 9.4 | 8.5 | 7.7 | 7.1 | 6.5 | - | - | |
| 10 | 23.0 | 19.3 | 16.6 | 14.6 | 13.0 | 11.7 | 9.8 | 8.4 | - | - | - | - | - | - | - | |
| 15 | 22.1 | 18.0 | 15.2 | 13.2 | 11.6 | 10.4 | - | - | - | - | - | - | - | - | - | |
| 30 | 20.2 | 15.6 | 12.7 | - | - | - | - | - | - | - | - | - | - | - | - | |
| 1 | 25.8 | 23.5 | 21.6 | 20.0 | 18.6 | 17.4 | 15.4 | 13.8 | 12.5 | 10.8 | 9.2 | 8.1 | 7.2 | 6.5 | 5.2 | 300 |
| 2 | 24.8 | 21.9 | 19.6 | 17.8 | 16.3 | 15.0 | 11.7 | 9.4 | 7.8 | 6.7 | 5.8 | 5.2 | 4.7 | 4.3 | 3.7 | |
| 3 | 24.1 | 20.8 | 18.4 | 16.4 | 14.8 | 13.5 | 10.2 | 8.2 | 6.8 | 5.8 | 5.1 | 4.5 | 4.1 | 3.7 | 3.3 | |
| 4 | 23.5 | 20.0 | 17.4 | 15.4 | 13.8 | 12.5 | 9.5 | 7.6 | 6.3 | 5.4 | 4.7 | 4.2 | 3.8 | 3.4 | 3.0 | |
| 5 | 23.0 | 19.3 | 16.6 | 14.6 | 13.0 | 11.7 | 9.0 | 7.2 | 6.0 | 5.2 | 4.5 | 4.0 | 3.6 | - | - | |
| 10 | 21.3 | 17.0 | 14.2 | 12.1 | 10.6 | 9.4 | 7.7 | 6.5 | - | - | - | - | - | - | - | |
| 15 | 20.2 | 15.6 | 12.7 | 10.8 | 9.3 | 8.2 | - | - | - | - | - | - | - | - | - | |
| 30 | 18.0 | 13.2 | 10.4 | - | - | - | - | - | - | - | - | - | - | - | - | |



Abaco per carichi in serie - Serial load rating - Abaque de charges successives
 ■ 1.0 - 3 ~ - 10000 min⁻¹

| Potenza ammessa sul tubo in kW, per serie di n esposizioni, con frequenza z e durata di ogni esposizione in sec | | | | | | | | | | | | | | | n | |
|--|-------|-------|-------|-------|-------|-------|-------|-------|-------|-------|-------|-------|-------|-------|-------|-----|
| Anode input power as a function of n (N° of exposures in series), z (exp. rate per sec), the exposure time (sec) | | | | | | | | | | | | | | | | |
| Puissance anodique en fonction de n (N° d'exp. de la séries), z (cadence d'exp. par sec), temps d'exposition (sec) | | | | | | | | | | | | | | | | |
| z | 0.010 | 0.020 | 0.030 | 0.040 | 0.050 | 0.060 | 0.080 | 0.100 | 0.120 | 0.140 | 0.160 | 0.180 | 0.200 | 0.220 | 0.250 | |
| 1 | 47.4 | 45.5 | 44.3 | 43.4 | 42.6 | 42.0 | 40.9 | 40.0 | 39.2 | 38.5 | 37.9 | 37.4 | 36.7 | 35.8 | 34.5 | 5 |
| 2 | 47.4 | 45.5 | 44.3 | 43.4 | 42.6 | 42.0 | 40.9 | 39.8 | 38.2 | 36.8 | 35.5 | 34.3 | 33.1 | 32.0 | 30.6 | |
| 3 | 47.4 | 45.5 | 44.3 | 43.4 | 42.6 | 42.0 | 39.9 | 38.1 | 36.3 | 34.8 | 33.4 | 32.0 | 30.8 | 29.7 | 28.1 | |
| 4 | 47.4 | 45.5 | 44.3 | 43.4 | 42.3 | 41.0 | 38.8 | 36.7 | 34.9 | 33.2 | 31.7 | 30.4 | 29.1 | 27.9 | 26.4 | |
| 5 | 47.4 | 45.5 | 44.3 | 42.9 | 41.5 | 40.2 | 37.8 | 35.6 | 33.7 | 32.0 | 30.4 | 29.0 | 27.8 | - | - | |
| 10 | 47.1 | 44.7 | 42.6 | 40.7 | 38.9 | 37.3 | 34.4 | 31.9 | - | - | - | - | - | - | - | |
| 15 | 46.6 | 43.8 | 41.3 | 39.1 | 37.1 | 35.3 | - | - | - | - | - | - | - | - | - | |
| 30 | 45.4 | 41.8 | 38.7 | - | - | - | - | - | - | - | - | - | - | - | - | |
| 1 | 47.4 | 45.5 | 44.3 | 43.4 | 42.6 | 42.0 | 40.9 | 39.8 | 38.2 | 36.8 | 35.5 | 34.3 | 33.1 | 32.0 | 30.6 | 10 |
| 2 | 47.4 | 45.5 | 44.3 | 43.4 | 42.2 | 41.0 | 38.7 | 36.7 | 34.9 | 33.2 | 31.7 | 30.3 | 29.1 | 27.9 | 26.3 | |
| 3 | 47.4 | 45.5 | 44.0 | 42.4 | 40.9 | 39.5 | 36.9 | 34.7 | 32.7 | 30.9 | 29.3 | 27.9 | 26.6 | 25.4 | 23.8 | |
| 4 | 47.4 | 45.2 | 43.2 | 41.4 | 39.8 | 38.2 | 35.5 | 33.1 | 31.0 | 29.2 | 27.6 | 26.1 | 24.8 | 23.6 | 22.1 | |
| 5 | 47.1 | 44.7 | 42.6 | 40.6 | 38.8 | 37.2 | 34.3 | 31.9 | 29.7 | 27.9 | 26.2 | 24.7 | 23.4 | - | - | |
| 10 | 46.1 | 42.9 | 40.2 | 37.8 | 35.6 | 33.7 | 30.4 | 27.8 | - | - | - | - | - | - | - | |
| 15 | 45.4 | 41.7 | 38.5 | 35.9 | 33.5 | 31.5 | - | - | - | - | - | - | - | - | - | |
| 30 | 43.8 | 39.1 | 35.3 | - | - | - | - | - | - | - | - | - | - | - | - | |
| 1 | 47.4 | 45.5 | 44.3 | 43.4 | 42.2 | 41.0 | 38.7 | 36.7 | 34.9 | 33.2 | 31.7 | 30.3 | 29.1 | 27.9 | 26.3 | 20 |
| 2 | 47.4 | 45.2 | 43.2 | 41.4 | 39.8 | 38.2 | 35.5 | 33.1 | 31.0 | 29.2 | 27.6 | 26.1 | 24.8 | 23.6 | 22.0 | |
| 3 | 46.9 | 44.3 | 42.0 | 39.9 | 38.0 | 36.3 | 33.3 | 30.8 | 28.6 | 26.7 | 25.1 | 23.6 | 22.3 | 21.1 | 19.6 | |
| 4 | 46.4 | 43.6 | 41.0 | 38.7 | 36.7 | 34.9 | 31.7 | 29.1 | 26.9 | 24.9 | 23.3 | 21.8 | 20.5 | 19.4 | 17.9 | |
| 5 | 46.1 | 42.9 | 40.2 | 37.8 | 35.6 | 33.7 | 30.4 | 27.7 | 25.5 | 23.6 | 21.9 | 20.5 | 19.2 | - | - | |
| 10 | 44.7 | 40.6 | 37.2 | 34.3 | 31.9 | 29.7 | 26.2 | 23.4 | - | - | - | - | - | - | - | |
| 15 | 43.7 | 39.0 | 35.2 | 32.1 | 29.5 | 27.3 | - | - | - | - | - | - | - | - | - | |
| 30 | 41.7 | 35.9 | 31.5 | - | - | - | - | - | - | - | - | - | - | - | - | |
| 1 | 47.4 | 45.2 | 43.2 | 41.4 | 39.8 | 38.2 | 35.5 | 33.1 | 31.0 | 29.2 | 27.6 | 26.1 | 24.8 | 23.0 | 20.2 | 40 |
| 2 | 46.4 | 43.6 | 41.0 | 38.7 | 36.7 | 34.9 | 31.7 | 29.1 | 26.8 | 24.9 | 23.3 | 21.8 | 20.5 | 19.4 | 17.9 | |
| 3 | 45.8 | 42.4 | 39.4 | 36.9 | 34.7 | 32.7 | 29.3 | 26.6 | 24.3 | 22.4 | 20.8 | 19.4 | 18.2 | 17.1 | 15.7 | |
| 4 | 45.2 | 41.4 | 38.2 | 35.5 | 33.1 | 31.0 | 27.6 | 24.8 | 22.6 | 20.7 | 19.1 | 17.7 | 16.5 | 15.5 | 14.2 | |
| 5 | 44.7 | 40.6 | 37.2 | 34.3 | 31.9 | 29.7 | 26.2 | 23.4 | 21.2 | 19.3 | 17.8 | 16.5 | 15.3 | - | - | |
| 10 | 42.9 | 37.8 | 33.7 | 30.4 | 27.7 | 25.5 | 21.9 | 19.2 | - | - | - | - | - | - | - | |
| 15 | 41.6 | 35.8 | 31.4 | 28.0 | 25.2 | 23.0 | - | - | - | - | - | - | - | - | - | |
| 30 | 39.0 | 32.1 | 27.3 | - | - | - | - | - | - | - | - | - | - | - | - | |
| 1 | 46.9 | 44.3 | 42.0 | 39.9 | 38.0 | 36.3 | 33.3 | 30.8 | 28.6 | 25.8 | 22.5 | 20.0 | 18.0 | 16.4 | 14.4 | 60 |
| 2 | 45.8 | 42.4 | 39.4 | 36.9 | 34.7 | 32.7 | 29.3 | 26.6 | 24.3 | 22.4 | 20.3 | 18.1 | 16.3 | 14.8 | 13.0 | |
| 3 | 45.0 | 41.0 | 37.7 | 34.9 | 32.4 | 30.3 | 26.8 | 24.1 | 21.8 | 20.0 | 18.4 | 17.0 | 15.7 | 14.2 | 12.5 | |
| 4 | 44.3 | 39.9 | 36.3 | 33.3 | 30.8 | 28.6 | 25.1 | 22.3 | 20.1 | 18.3 | 16.8 | 15.5 | 14.4 | 13.4 | 12.2 | |
| 5 | 43.7 | 39.0 | 35.2 | 32.1 | 29.5 | 27.2 | 23.7 | 20.9 | 18.8 | 17.0 | 15.5 | 14.3 | 13.3 | - | - | |
| 10 | 41.6 | 35.8 | 31.4 | 28.0 | 25.2 | 23.0 | 19.5 | 16.9 | - | - | - | - | - | - | - | |
| 15 | 40.2 | 33.7 | 29.0 | 25.5 | 22.7 | 20.5 | - | - | - | - | - | - | - | - | - | |
| 30 | 37.2 | 29.7 | 24.7 | - | - | - | - | - | - | - | - | - | - | - | - | |
| 1 | 46.4 | 43.6 | 41.0 | 38.7 | 36.7 | 34.9 | 31.7 | 28.8 | 24.0 | 20.6 | 18.0 | 16.0 | 14.4 | 13.1 | 11.5 | 80 |
| 2 | 45.2 | 41.4 | 38.2 | 35.5 | 33.1 | 31.0 | 27.6 | 24.8 | 21.1 | 18.0 | 15.8 | 14.0 | 12.6 | 11.5 | 10.1 | |
| 3 | 44.3 | 39.9 | 36.3 | 33.3 | 30.8 | 28.6 | 25.1 | 22.3 | 20.1 | 17.2 | 15.0 | 13.4 | 12.0 | 10.9 | 9.6 | |
| 4 | 43.6 | 38.7 | 34.9 | 31.7 | 29.1 | 26.8 | 23.3 | 20.5 | 18.4 | 16.6 | 14.7 | 13.0 | 11.7 | 10.7 | 9.4 | |
| 5 | 42.9 | 37.7 | 33.7 | 30.4 | 27.7 | 25.5 | 21.9 | 19.2 | 17.1 | 15.4 | 14.0 | 12.8 | 11.6 | - | - | |
| 10 | 40.6 | 34.3 | 29.7 | 26.2 | 23.4 | 21.2 | 17.8 | 15.3 | - | - | - | - | - | - | - | |
| 15 | 39.0 | 32.1 | 27.3 | 23.7 | 20.9 | 18.8 | - | - | - | - | - | - | - | - | - | |
| 30 | 35.8 | 28.0 | 23.0 | - | - | - | - | - | - | - | - | - | - | - | - | |
| 1 | 46.1 | 42.9 | 40.2 | 37.7 | 35.6 | 33.7 | 30.4 | 24.5 | 20.4 | 17.5 | 15.3 | 13.6 | 12.2 | 11.1 | 9.8 | 100 |
| 2 | 44.7 | 40.6 | 37.2 | 34.3 | 31.8 | 29.7 | 26.2 | 20.9 | 17.4 | 14.9 | 13.1 | 11.6 | 10.5 | 9.5 | 8.4 | |
| 3 | 43.7 | 39.0 | 35.2 | 32.1 | 29.5 | 27.2 | 23.7 | 19.7 | 16.4 | 14.1 | 12.3 | 11.0 | 9.9 | 9.0 | 7.9 | |
| 4 | 42.9 | 37.7 | 33.7 | 30.4 | 27.7 | 25.5 | 21.9 | 19.1 | 16.0 | 13.7 | 12.0 | 10.6 | 9.6 | 8.7 | 7.7 | |
| 5 | 42.2 | 36.7 | 32.4 | 29.1 | 26.3 | 24.1 | 20.5 | 17.9 | 15.7 | 13.4 | 11.7 | 10.4 | 9.4 | - | - | |
| 10 | 39.8 | 33.1 | 28.4 | 24.8 | 22.0 | 19.8 | 16.5 | 14.2 | - | - | - | - | - | - | - | |
| 15 | 38.0 | 30.8 | 25.9 | 22.3 | 19.6 | 17.5 | - | - | - | - | - | - | - | - | - | |
| 30 | 34.7 | 26.6 | 21.6 | - | - | - | - | - | - | - | - | - | - | - | - | |
| 1 | 45.3 | 41.6 | 38.5 | 35.8 | 33.5 | 31.2 | 23.4 | 18.7 | 15.6 | 13.4 | 11.7 | 10.4 | 9.4 | 8.5 | 7.5 | 150 |
| 2 | 43.7 | 39.0 | 35.2 | 32.1 | 29.5 | 25.2 | 18.9 | 15.1 | 12.6 | 10.8 | 9.5 | 8.4 | 7.6 | 6.9 | 6.1 | |
| 3 | 42.6 | 37.2 | 33.0 | 29.7 | 27.0 | 23.3 | 17.4 | 14.0 | 11.6 | 10.0 | 8.7 | 7.8 | 7.0 | 6.3 | 5.6 | |
| 4 | 41.6 | 35.8 | 31.4 | 28.0 | 25.2 | 22.3 | 16.7 | 13.4 | 11.1 | 9.5 | 8.3 | 7.4 | 6.7 | 6.1 | 5.3 | |
| 5 | 40.9 | 34.7 | 30.1 | 26.6 | 23.8 | 21.6 | 16.3 | 13.0 | 10.8 | 9.3 | 8.1 | 7.2 | 6.5 | - | - | |
| 10 | 38.0 | 30.8 | 25.9 | 22.3 | 19.6 | 17.5 | 14.4 | 12.2 | - | - | - | - | - | - | - | |
| 15 | 36.1 | 28.4 | 23.3 | 19.8 | 17.2 | 15.3 | - | - | - | - | - | - | - | - | - | |
| 30 | 32.5 | 24.1 | 19.1 | - | - | - | - | - | - | - | - | - | - | - | - | |
| 1 | 43.7 | 39.0 | 35.2 | 32.1 | 25.9 | 21.5 | 16.2 | 12.9 | 10.8 | 9.2 | 8.1 | 7.2 | 6.5 | 5.9 | 5.2 | 300 |
| 2 | 41.6 | 35.8 | 31.2 | 23.4 | 18.7 | 15.6 | 11.7 | 9.4 | 7.8 | 6.7 | 5.8 | 5.2 | 4.7 | 4.3 | 3.7 | |
| 3 | 40.2 | 33.7 | 27.2 | 20.4 | 16.3 | 13.6 | 10.2 | 8.2 | 6.8 | 5.8 | 5.1 | 4.5 | 4.1 | 3.7 | 3.3 | |
| 4 | 39.0 | 32.1 | 25.2 | 18.9 | 15.1 | 12.6 | 9.5 | 7.6 | 6.3 | 5.4 | 4.7 | 4.2 | 3.8 | 3.4 | 3.0 | |
| 5 | 38.0 | 30.8 | 24.0 | 18.0 | 14.4 | 12.0 | 9.0 | 7.2 | 6.0 | 5.2 | 4.5 | 4.0 | 3.6 | - | - | |
| 10 | 34.7 | 26.6 | 21.6 | 16.3 | 13.0 | 10.8 | 8.1 | 6.5 | - | - | - | - | - | - | - | |
| 15 | 32.4 | 24.1 | 19.1 | 15.7 | 12.5 | 10.4 | - | - | - | - | - | - | - | - | - | |
| 30 | 28.4 | 19.8 | 15.3 | - | - | - | - | - | - | - | - | - | - | - | - | |

Caratteristica di emissione del catodo
Cathode emission characteristic
Caractéristique d'émission de la cathode
 ■ 0.6 - 3 ~ - (± 0.2 A)

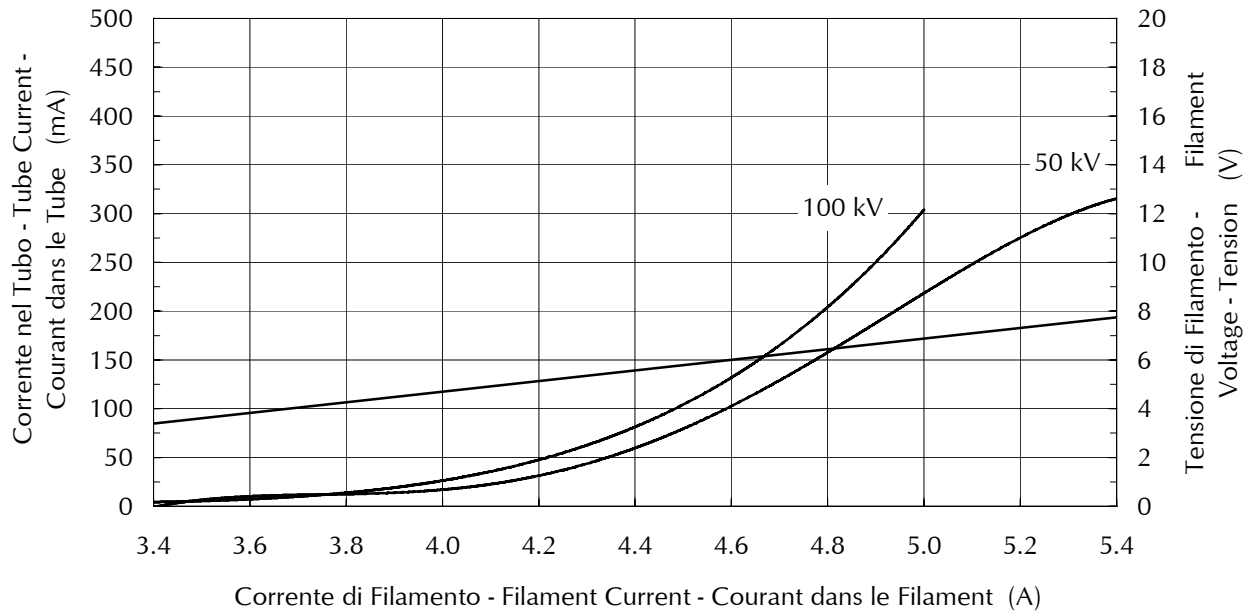

Caratteristica di emissione del catodo
Cathode emission characteristic
Caractéristique d'émission de la cathode
 ■ 1.0 - 3 ~ - (± 0.2 A)

